

EC2B Series Control Boxes (Flameproof & Increased Safety)

Complies with IECEx, ATEX, Ex-CCC, UL/c-UL and TIIS. Ideal for use in factories.

- Corrosion resistant stainless steel enclosure.
- Applicable in areas where explosive gases/steam exist including hydrogen and acetylene, and environments subject to dust (ATEX, IECEx, Ex-CCC).
- Available with a variety of switches/pilot lights and enclosures.
- Available for global applications
Global: IECEx
North America: UL/c-UL
Europe: CE/ATEX
China: Ex-CCC
Japan: TIIS
- Degree of protection: IP65 (IEC 60529), Type4X (UL)



Specifications

Degree of protection	IP65 (IEC60529), Type 4X (UL)
Housing Material	Stainless steel (SUS304)
Standard Coating *	5Y7/1 (semi gloss) melamine baking (coating thickness: 10 µm) 1-column: Outside coating 2-, 3-, 4-column: Inside and outside coating
Rated Insulation Voltage	600V (with pilot light or ET2A-8PE screw terminal block: 500V) Meter AC input: 300V Meter DC input: 150V
Insulation Resistance	100 MΩ minimum (500V DC megger)
Operating Temperature	-20 to +50°C (no freezing)
Operating Humidity	45 to 85% (no condensation)
Altitude	2000m maximum

- * Special coating, buffing (#400), and special color are possible.
- * Contact IDEC for details.

Explosion protection specifications and certification number

Certification	Explosion Protection	Certification No.
TIIS	Ex de IIC T6	See Page 24
IECEx	Ex db eb IIC T6 Gb Ex tb IIIC T80°C Db (dust)	IECEx PTB 15.0032
ATEX	Ex db eb IIC T6 Gb Ex tb IIIC T80°C Db (dust)	PTB 08 ATEX 1048
UL	Class I, Zone 1 AEx d e IIC T6 Gb Class I Div 2, Groups A, B, C and D	E347230
c-UL Without pilot light	Class I, Zone 1, Ex de IIC T6 Gb Class I Div 2, Groups A, B, C and D	
c-UL With pilot light	Class I, Zone 1, Ex de IIB T6 Gb Class I, Div 2, Groups C and D	
Ex-CCC	Ex de IIC T6 Gb Ex tD A21 IP65 T80°C (dust)	202001230434 8115

IECEx/ATEX/Ex-CCC, UL/c-UL/ IECEx/ATEX, and TIIS Comparison

	IECEx/ATEX/Ex-CCC certified	UL/c-UL, IECEx/ATEX certified	TIIS certified	
Part No.	EC2B-□-GL	EC2B-□-U	EC2B-□	
Applicable Enclosure	All enclosures	All enclosures except for 6 Control Units x 4 Column	All enclosures	
Mounting Style	Wall Mount	Wall Mount	Wall Mount Pole Mount	
Applicable Control Unit	Pilot Light	Yes (*1)	Yes	
	Pushbutton	Yes (*2)	Yes	
	Emergency Pushbutton	Yes	Yes	
	Selector Switch	Yes	Yes	
	Key Selector Switch	Yes	Yes	
	Meter	Yes	Yes	
	Buzzer	—	—	Yes (*3)
	Variable Resistor	—	—	Yes
Reducer Screw	Metric Thread (standard)	NPT Thread (standard)	Pipe Parallel Thread (standard)	
	NPT Thread/Pipe Parallel Thread	Metric Thread	Metric Thread/NPT Thread	
Cable Lead-in Fitting	— (*4)	— (*4)	Yes (HPN)	
Lead-in Port Plug	— (*4)	— (*4)	Yes (GBE)	
Degree of Protection	IP65	IP65, TYPE4X (UL)	IP65	
Grounding Terminal Screw Material	Stainless Steel	Stainless Steel	Brass	
Applicable Wire	Stranded Wire (mm ²)	1.25 to 2.5	1.25 to 2.5	
	Solid Wire (mm ²)	1.2 to 1.6	1.2 to 1.6	
	Solid/Stranded Wire (AWG)	16-14	16-14	

- *1: c-UL explosion protection is different when pilot light is installed.
- *2: Part no. is different from TIIS certified model.
- *3: Part no. of TIIS certified meter is different from the meter certified by other organizations.
- *4: Use fittings and plugs commercially available compliant to the corresponding standards.

Control Boxes (TIIS, IECEx, ATEX, Ex-CCC, UL/c-UL)

Control Box

	1, 2 control units	3 control units	4 control units	5 control units		6 control units
1-column					3-column	
2-column						Not certified by UL/c-UL
3-column						4-column

Control Units

Control Unit	Pilot Light			Pushbutton			Emergency Stop Switch
Shape	Round			Flush	Extended	Mushroom	Mushroom (ø40)
Operation	—			Momentary			Push-to-lock, pull or turn-to-reset
Shape							
Illumination color/button color	R (red) G (green) Y (yellow) A (amber) W (white) S (blue) PW (pure white)			B (black) G (green) R (red) W (white) Y (yellow) S (blue)			R (red)
Part No.	EU2B-YL			EU2B-YB1	EU2B-YB2	EU2B-YB3	EU2B-YBV
Page	15			15			15
Control Unit	Selector Switch		Buzzer (*)	Variable Reducer (*)	Meter		
	Knob Operator	Key					
Shape							
Part No.	EU2B-YS	EU2B-YSK	EC9F-Z	EC9E-R	EU2B-YM/EC9F-M		
Page	16		16	17	17		

* Only approved under TIIS standards.

Nameplate/Mounting Hole Plug

Name	Control Unit Nameplate	Marking Plates for Control Unit Nameplates	Emergency Stop Switch Nameplate Sticker	Control Unit Mounting Hole Plug
Shape				
Part No.	EU9Z-NM	EU9Z-NP	EU9Z-NVS	EU9Z-BP
Page	23	23	23	23

* See page 21 for accessories.

Standard Part No. Development (reference)

The chart below describes the configuration of standard model. See next page for standard model.

For custom order models, contact IDEC for part number, prices, and delivery time. Please use this chart for interpreting part numbers, not for developing part numbers.

EC2B-11 01 B F2 N C 1 0 - GL

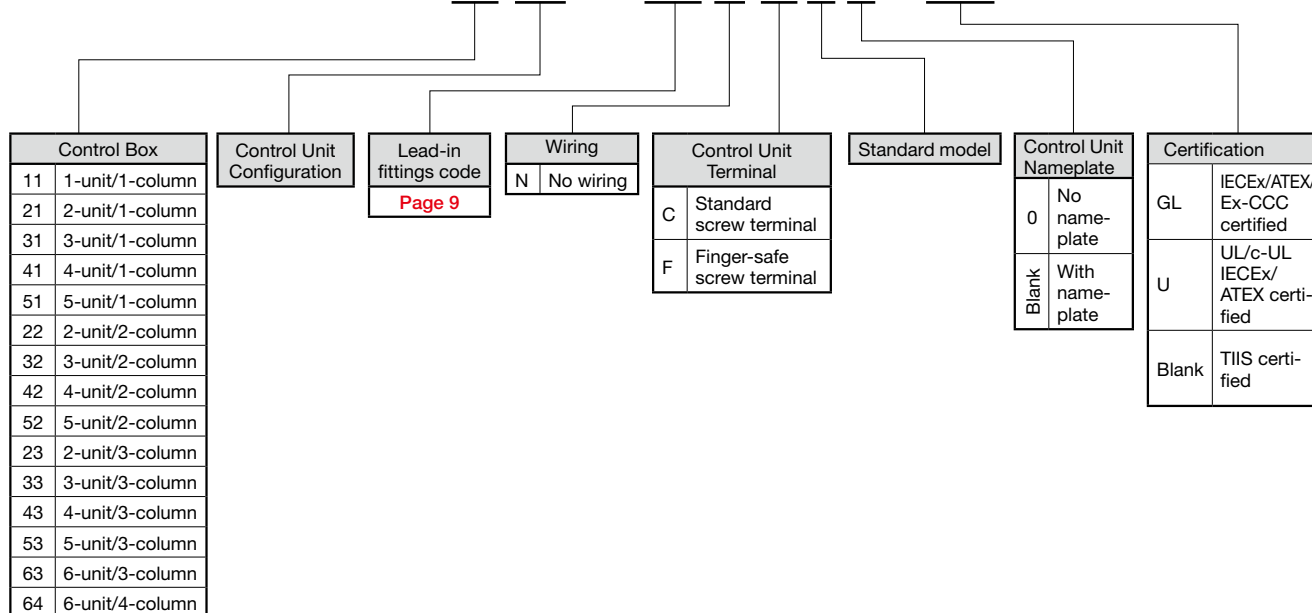

Standard control box

- Specify the Part No. when ordering standard control boxes.
- For control unit specifications and part numbers, see pages 13 to 17. For cable lead-in fitting specifications, see page 9. For specifications of control unit nameplate and emergency stop switch nameplate sticker, see page 23.
- If a control unit nameplate or emergency stop switch nameplate sticker is not required on standard control boxes, add "0" after the Part No.

Example: **EC2B-1102BF2NC10**

Custom assembled control box

- If the required control units, accessories, and cable lead-in fittings are not standard specifications, and if control box nameplate (NP) is required, specify the required specifications on the Specification Sheet on pages 29 to 30.
- TIIS certified models: the model and number of control units that can be installed depend on the size of control box. See page 24 for TIIS certified products and specify the control unit configuration.

Standard and custom assembled control boxes

- Part No. is shown on control boxes as below.

TIIS certified

TIIS certified part no. (see page 24.)

Part No. Example

Wall mount

Part No: **EC2B-1102BF2NF2**

Part No. on control box: **EC2B-1102-F**

IECEx/ATEX/Ex-CCC certified

EC2B-□□□□-GL

Part No. Example

Part No: **EC2B-1102BM3NC3-GL**

Part No. on control box: **EC2B-1102-GL**

UL/c-UL, IECEx/ATEX certified

EC2B-□□□□-U

Part No. Example

Part No: **EC2B-1102BN2F4-U**

Part No. on control box: **EC2B-1102-U**

- See below for the symbols of control units.

- Ⓟ : Pilot light
- Ⓟ : Pushbutton
- Ⓟ : Emergency stop switch
- Ⓟ : Selector switch/Key selector switch
- Ⓟ : Meter
- Ⓟ : Buzzer
- Ⓟ : Variable Resistor
- Ⓟ : Control Unit Mounting Hole Plug

Control Boxes

1 Control Unit × 1 Column (without wiring) (standard models)

Pushbuttons

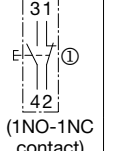
Shape/Symbol		Mounted Control Units			
		Flush momentary 1NO contact Nameplate ON Button color (supplied with black, green, red, and white buttons)	Flush momentary 1NC contact Nameplate OFF Button color (supplied with black, green, red, and white buttons)	Flush momentary 1NO-1NC contact Nameplate ON Button color (supplied with black, green, red, and white buttons)	Flush momentary 1NO-1NC contact Nameplate OFF Button color (supplied with black, green, red, and white buttons)
Part No. (IECEX/ATEX/Ex-CCC certified)		EC2B-1102BM3N□1-GL	EC2B-1102BM3N□2-GL	EC2B-1102BM3N□3-GL	EC2B-1102BM3N□4-GL
Part No. (UL/c-UL, IECEX/ATEX certified)		EC2B-1102BN2N□1-U	EC2B-1102BN2N□2-U	EC2B-1102BN2N□3-U	EC2B-1102BN2N□4-U
Part No. (TIIS certified)		EC2B-1102BF2N□1	EC2B-1102BF2N□2	EC2B-1102BF2N□3	EC2B-1102BF2N□4
TIIS Type Test Approval No. (*)	C terminal style	TC19254	TC19254	TC19254	TC19254
	F terminal style	TC19255	TC19255	TC19255	TC19255

Pilot Lights

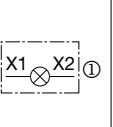
Shape/Symbol		Mounted Control Units					
		100/110V AC Illumination color: red	200/220V AC Illumination color: red	24V AC/DC Illumination color: red	100/110V AC Illumination color: green	200/220V AC Illumination color: green	24V AC/DC Illumination color: green
Part No. (IECEX/ATEX/Ex-CCC certified)		EC2B-1101BM3N□1-GL	EC2B-1101BM3N□2-GL	EC2B-1101BM3N□3-GL	EC2B-1101BM3N□4-GL	EC2B-1101BM3N□5-GL	EC2B-1101BM3N□6-GL
Part No. (UL/c-UL, IECEX/ATEX certified)		EC2B-1101BN2N□1-U	EC2B-1101BN2N□2-U	EC2B-1101BN2N□3-U	EC2B-1101BN2N□4-U	EC2B-1101BN2N□5-U	EC2B-1101BN2N□6-U
Part No. (TIIS certified)		EC2B-1101BF2N□1	EC2B-1101BF2N□2	EC2B-1101BF2N□3	EC2B-1101BF2N□4	EC2B-1101BF2N□5	EC2B-1101BF2N□6
TIIS Type Test Approval No. (*)	C terminal style	TC19254	TC19254	TC19254	TC19254	TC19254	TC19254
	F terminal style	TC19255	TC19255	TC19255	TC19255	TC19255	TC19255

Emergency Stop Switches

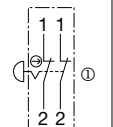
Shape/Symbol		Mounted Control Units
		Emergency stop switch 2NC contact Nameplate EMERGENCY STOP Button color (red)
Part No. (IECEX/ATEX/Ex-CCC certified)		EC2B-1102BM3N□7-GL
Part No. (UL/c-UL, IECEX/ATEX certified)		EC2B-1102BN2N□7-U
Part No. (TIIS certified)		EC2B-1102BF2N□7
TIIS Type Test Approval No. (*)	C terminal style	TC19254
	F terminal style	TC19255



• Specify terminal style code in place of in part no. C (standard screw terminal), F (finger-safe screw terminal)

• Contact IDEC for custom assembled control boxes.

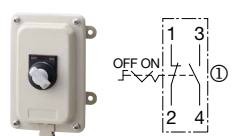

* C terminal style (exposed screw terminal) and F terminal style (finger-safe screw terminal) have different TIIS certification numbers.

1 Control Unit × 1 Column (without wiring) (standard models)

Selector Switches

Shape/Symbol		Mounted Control Units	
	①	Knob selector 2-position maintained 1NO-1NC contact Name plate OFF-ON	
Part No. (IECEX/ATEX/Ex-CCC certified)		EC2B-1106BM3N□1-GL	
Part No. (UL/c-UL, IECEX/ATEX certified)		EC2B-1106BN2N□1-U	
Part No. (TIIS certified)		EC2B-1106BF2N□1	
TIIS Type Test Approval No. (*)	C terminal style	TC19256	
	F terminal style	TC19257	

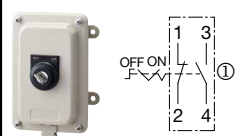
Key Selector Switches

Shape/Symbol		Mounted Control Units	
	①	Key selector 2-position maintained (removable at all positions) 1NO-1NC contact Nameplate OFF-ON	
Part No. (IECEX/ATEX/Ex-CCC certified)		EC2B-1106BM3N□4-GL	
Part No. (UL/c-UL, IECEX/ATEX certified)		EC2B-1106BN2N□4-U	
Part No. (TIIS certified)		EC2B-1106BF2N□4	
TIIS Type Test Approval No. (*)	C terminal style	TC19256	
	F terminal style	TC19257	

2 Control Units × 1 Column (without wiring) (standard models)

Two Flush Pushbuttons

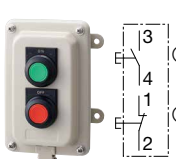
Shape/Symbol		Mounted Control Units	
	①	Flush momentary 1NO contact, Nameplate ON Button color (supplied with black, green, red, and white buttons)	
	②	Flush momentary 1NC contact, Nameplate OFF Button color (supplied with black, green, red, and white buttons)	
Part No. (IECEX/ATEX/Ex-CCC certified)		EC2B-2102BM3N□1-GL	
Part No. (UL/c-UL, IECEX/ATEX certified)		EC2B-2102BN2N□1-U	
Part No. (TIIS certified)		EC2B-2102BF2N□1	
TIIS Type Test Approval No. (*)	C terminal style	TC19254	
	F terminal style	TC19255	

Two Mushroom Pushbuttons

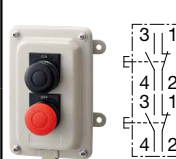
Shape/Symbol		Mounted Control Units	
	①	Mushroom momentary 1NO-1NC contact, Nameplate ON Button color (black)	
	②	Mushroom momentary 1NO-1NC contact, Nameplate OFF Button color (red)	
Part No. (IECEX/ATEX/Ex-CCC certified)		EC2B-2102BM3N□4-GL	
Part No. (UL/c-UL, IECEX/ATEX certified)		EC2B-2102BN2N□4-U	
Part No. (TIIS certified)		EC2B-2102BF2N□4	
TIIS Type Test Approval No. (*)	C terminal style	TC19254	
	F terminal style	TC19255	

Combination Pilot Lights/Pushbuttons

Shape/Symbol		Mounted Control Units			
	①	100/110V AC Illumination color: red	200/220V AC Illumination color: red	24V AC/DC Illumination color: red	
	②	Flush momentary 1NO-1NC contact Name plate STOP Button color (supplied with black, green, red, and white buttons)	Flush momentary 1NO-1NC contact Name plate STOP Button color (supplied with black, green, red, and white buttons)	Flush momentary 1NO-1NC contact Name plate STOP Button color (supplied with black, green, red, and white buttons)	
Part No. (IECEX/ATEX/Ex-CCC certified)		EC2B-2110BM3N□1-GL	EC2B-2110BM3N□2-GL	EC2B-2110BM3N□3-GL	
Part No. (UL/c-UL, IECEX/ATEX certified)		EC2B-2110BN2N□1-U	EC2B-2110BN2N□2-U	EC2B-2110BN2N□3-U	
Part No. (TIIS certified)		EC2B-2110BF2N□1	EC2B-2110BF2N□2	EC2B-2110BF2N□3	
TIIS Type Test Approval No. (*)	C terminal style	TC19254	TC19254	TC19254	
	F terminal style	TC19255	TC19255	TC19255	



• Specify terminal style code in place of in part no. C (standard screw terminal), F (finger-safe screw terminal)

• Contact IDEC for custom assembled control boxes.

* C terminal style (exposed screw terminal) and F terminal style (finger-safe screw terminal) have different TIIS certification numbers.

2 Control Units × 1 Column (without wiring) (standard models)

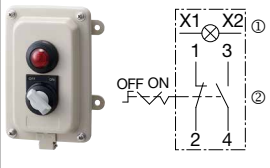
Combination Pilot Light/Selector Switch

Shape/Symbol		Mounted Control Units	
	①	100/110V AC Illumination color: red	200/220V AC Illumination color: red
	②	Knob, 2-position, 1NO-1NC contact Maintained, Name plate OFF-ON 	Knob, 2-position, 1NO-1NC contact Maintained, Name plate OFF-ON 
Part No. (IECEX/ATEX/Ex-CCC certified)		EC2B-2117BM3N□1-GL	EC2B-2117BM3N□2-GL
Part No. (UL/c-UL, IECEX/ATEX certified)		EC2B-2117BN2N□1-U	EC2B-2117BN2N□2-U
Part No. (TIIS certified)		EC2B-2117BF2N□1	EC2B-2117BF2N□2
TIIS Type Test Approval No. (*)	C terminal style	TC19258	TC19258
	F terminal style	TC19259	TC19259

3 Control Units × 1 Column (without wiring) (standard models)

Combination 1 pilot light/2 pushbuttons

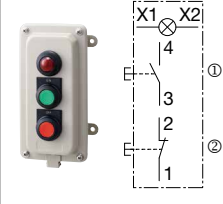
Shape/Symbol		Mounted Control Units		
	①	100/110V AC Illumination color: red	200/220V AC Illumination color: red	24V AC/DC Illumination color: red
	②	Flush momentary 1NO contact, Nameplate ON Button color (supplied with black, green, red, and white buttons)	Flush momentary 1NO contact, Nameplate ON Button color (supplied with black, green, red, and white buttons)	Flush momentary 1NO contact, Nameplate ON Button color (supplied with black, green, red, and white buttons)
	③	Flush momentary 1NC contact, Nameplate OFF Button color (supplied with black, green, red, and white buttons)	Flush momentary 1NC contact, Nameplate OFF Button color (supplied with black, green, red, and white buttons)	Flush momentary 1NC contact, Nameplate OFF Button color (supplied with black, green, red, and white buttons)
Part No. (IECEX/ATEX/Ex-CCC certified)		EC2B-3110BM3N□1-GL	EC2B-3110BM3N□2-GL	EC2B-3110BM3N□3-GL
Part No. (UL/c-UL, IECEX/ATEX certified)		EC2B-3110BN2N□1-U	EC2B-3110BN2N□2-U	EC2B-3110BN2N□3-U
Part No. (TIIS certified)		EC2B-3110BF2N□1	EC2B-3110BF2N□2	EC2B-3110BF2N□3
TIIS Type Test Approval No. (*)	C terminal style	TC19260	TC19260	TC19260
	F terminal style	TC19261	TC19261	TC19261

3 Pushbuttons

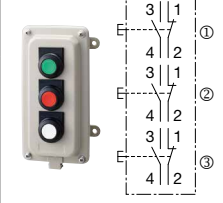
Shape/Symbol		Mounted Control Units
	①	Flush momentary 1NO-1NC contact, Blank nameplate Button color (supplied with black, green, red, and white buttons)
	②	
	③	
Part No. (IECEX/ATEX/Ex-CCC certified)		EC2B-3102BM3N□1-GL
Part No. (UL/c-UL, IECEX/ATEX certified)		EC2B-3102BN2N□1-U
Part No. (TIIS certified)		EC2B-3102BF2N□1
TIIS Type Test Approval No. (*)	C terminal style	TC19260
	F terminal style	TC19261

1 Meter/2 Pushbuttons

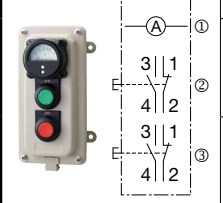
Shape/Symbol		Mounted Control Units
	①	Specify input, capacity, and scale
	②	Flush momentary 1NO-1NC contact, Nameplate ON Button color (supplied with black, green, red, and white buttons)
	③	Flush momentary 1NO-1NC contact, Nameplate OFF Button color (supplied with black, green, red, and white buttons)
Part No. (IECEX/ATEX/Ex-CCC certified)		EC2B-3152BM3N□1△-GL
Part No. (UL/c-UL, IECEX/ATEX certified)		EC2B-3152BN2N□1△-U

- Specify the meter's capacity and scale in place of Δ in the part no. See page 17 for details. Contact IDEC for custom assembled control boxes.
- TIIS certified control box equipped with a meter is available with combination of other than 1 unit/1 column, 2 units/1 column, and 3 units/1 column.

- Specify terminal style code in place of in part no. C (standard screw terminal), F (finger-safe screw terminal)
- Contact IDEC for custom assembled control boxes.

* C terminal style (exposed screw terminal) and F terminal style (finger-safe screw terminal) have different TIIS certification numbers.

4 Control Units × 1 Column (without wiring) (standard models)

2 pilot lights/2 pushbuttons

Shape/Symbol		Mounted Control Units		
	①	100/110V AC, Illumination color: red	200/220V AC, Illumination color: red	24V AC/DC, Illumination color: red
	②	100/110V AC, Illumination color: green	200/220V AC, Illumination color: green	24V AC/DC, Illumination color: green
	③	Flush momentary 1NO-1NC contact, Nameplate ON Button color (supplied with black, green, red, and white buttons)	Flush momentary 1NO-1NC contact, Nameplate ON Button color (supplied with black, green, red, and white buttons)	Flush momentary 1NO-1NC contact, Nameplate ON Button color (supplied with black, green, red, and white buttons)
	④	Flush momentary 1NO-1NC contact, Nameplate OFF Button color (supplied with black, green, red, and white buttons)	Flush momentary 1NO-1NC contact, Nameplate OFF Button color (supplied with black, green, red, and white buttons)	Flush momentary 1NO-1NC contact, Nameplate OFF Button color (supplied with black, green, red, and white buttons)
Part No. (IECEX/ATEX/Ex-CCC certified)		EC2B-4110BM4N□1-GL	EC2B-4110BM4N□2-GL	EC2B-4110BM4N□3-GL
Part No. (UL/c-UL, IECEX/ATEX certified)		EC2B-4110BN3N□1-U	EC2B-4110BN3N□2-U	EC2B-4110BN3N□3-U
Part No. (TIIS certified)		EC2B-4110BF3N□1	EC2B-4110BF3N□2	EC2B-4110BF3N□3
TIIS Type Test Approval No. (*)	C/F terminal style	TC19262	TC19262	TC19262

1 pilot light/2 pushbuttons/1 selector switch

Shape/Symbol		Mounted Control Units		
	①	100/110V AC, Illumination color: red	200/220V AC, Illumination color: red	24V AC/DC, Illumination color: red
	②	Flush momentary 1NO-1NC contact, Nameplate ON Button color (supplied with black, green, red, and white buttons)	Flush momentary 1NO-1NC contact, Nameplate ON Button color (supplied with black, green, red, and white buttons)	Flush momentary 1NO-1NC contact, Nameplate ON Button color (supplied with black, green, red, and white buttons)
	③	Flush momentary 1NO-1NC contact, Nameplate OFF Button color (supplied with black, green, red, and white buttons)	Flush momentary 1NO-1NC contact, Nameplate OFF Button color (supplied with black, green, red, and white buttons)	Flush momentary 1NO-1NC contact, Nameplate OFF Button color (supplied with black, green, red, and white buttons)
	④	Knob, 2-position, maintained 1NO-1NC contact, Nameplate HAND-AUTO	Knob, 2-position, maintained 1NO-1NC contact, Nameplate HAND-AUTO	Knob, 2-position, maintained 1NO-1NC contact, Nameplate HAND-AUTO
Part No. (IECEX/ATEX/Ex-CCC certified)		EC2B-4113BM4N□1-GL	EC2B-4113B□4N□2-GL	EC2B-4113B□4N□3-GL
Part No. (UL/c-UL, IECEX/ATEX certified)		EC2B-4113BN3N□1-U	EC2B-4113BN3N□2-U	EC2B-4113BN3N□3-U
Part No. (TIIS certified)		EC2B-4113BF3N□1	EC2B-4113BF3N□2	EC2B-4113BF3N□3
TIIS Type Test Approval No. (*)	C/F terminal style	TC19262	TC19262	TC19262

5 Control Units × 1 Column (without wiring) (standard models)

2 pilot lights/2 pushbuttons/1 selector switch

Shape/Symbol		Mounted Control Units		
	①	100/110V AC, Illumination color: red	200/220V AC, Illumination color: red	24V AC/DC, Illumination color: red
	②	100/110V AC, Illumination color: green	100/110V AC, Illumination color: green	24V AC/DC, Illumination color: green
	③	Flush momentary 1NO-1NC contact, Nameplate ON Button color (supplied with black, green, red, and white buttons)	Flush momentary 1NO-1NC contact, Nameplate ON Button color (supplied with black, green, red, and white buttons)	Flush momentary 1NO-1NC contact, Nameplate ON Button color (supplied with black, green, red, and white buttons)
	④	Flush momentary 1NO-1NC contact, Nameplate OFF Button color (supplied with black, green, red, and white buttons)	Flush momentary 1NO-1NC contact, Nameplate OFF Button color (supplied with black, green, red, and white buttons)	Flush momentary 1NO-1NC contact, Nameplate OFF Button color (supplied with black, green, red, and white buttons)
	⑤	Knob, 2-position, Main- tained, 1NO-1NC contact, Name plate HAND-AUTO	Knob, 2-position, Main- tained, 1NO-1NC contact, Name plate HAND-AUTO	Knob, 2-position, Main- tained, 1NO-1NC contact, Name plate HAND-AUTO
Part No. (IECEX/ATEX/Ex-CCC certified)		EC2B-5113BM4N□1-GL	EC2B-5113BM4N□2-GL	EC2B-5113BM4N□3-GL
Part No. (UL/c-UL, IECEX/ATEX certified)		EC2B-5113BN3N□1-U	EC2B-5113BN3N□2-U	EC2B-5113BN3N□3-U
Part No. (TIIS certified)		EC2B-5113BF3N□1	EC2B-5113BF3N□2	EC2B-5113BF3N□3
TIIS Type Test Approval No. (*)	C/F terminal style	TC19262	TC19262	TC19262

- Specify terminal style code in place of in part no. C (standard screw terminal), F (finger-safe screw terminal)
- Contact IDEC for custom assembled control boxes.

* C terminal style (exposed screw terminal) and F terminal style (finger-safe screw terminal) have different TIIS certification numbers.

Cable Lead-in Fittings

Wall Mount Reducers

Reducers installed at the bottom of the control box are as follows:

- 1 column: 1 reducer
- 2 columns: 2 reducers
- 3 columns: 3 reducers
- 4 columns: 4 reducers

Material: brass (nickel-plated)



The following optional reducers can also be installed.

Control Box Style	Part No.	Thread Size	Symbol	Approval			
				IECEX ATEX Ex-CCC	UL c-UL	TIIS	
1 column (1 to 3 control units)	EC9E-H31 [*1]	G1/2 (16)	F1	○	—	○	
	EC9E-H32 [*1]	G3/4 (22)	F2	○	—	●	
	EC9E-H33 [*1]	G1 (28)	F3	○	—	○	
	EC9E-H3M16 [*2]	M16	M1	○	○	○	
	EC9E-H3M20 [*2]	M20	M2	○	○	○	
	2, 3 columns (2, 3 control units)	EC9E-H3M25 [*2]	M25	M3	●	○	○
		EC9E-H3M32 [*2]	M32	M4	○	○	○
		EC9E-H3NPT1 [*2]	NPT 1/2	N1	○	○	○
		EC9E-H3NPT2 [*2]	NPT 3/4	N2	○	●	○
	1, 2, 3 columns (4, 5 control units)	EC9E-H3NPT3 [*2]	NPT 1	N3	○	○	○
EC9E-H42 [*1]		G3/4 (22)	F2	○	—	○	
EC9E-H43 [*1]		G1 (28)	F3	○	—	●	
EC9E-H44 [*1]		G1 1/4 (36)	F4	○	—	○	
3, 4 columns (6 control units)		EC9E-H4M25 [*2]	M25	M3	○	○	○
		EC9E-H4M32 [*2]	M32	M4	●	○	○
		EC9E-H4M40 [*2]	M40	M5	○	○	○
		EC9E-H4NPT2 [*2]	NPT 3/4	N2	○	○	○
		EC9E-H4NPT3 [*2]	NPT 1	N3	○	●	○
		EC9E-H4NPT4 [*2]	NPT 1 1/4	N4	○	○	○

- : Standard reducer
- : Except for standard reducer
- Specify the reducer certification in place of []
 - [*1] E: IECEX, ATEX, Ex-CCC
Blank: TIIS certified
 - [*2] E-UL: IECx/ATEX, UL/c-UL certified
Blank: TIIS certified
- The value in () is the nominal designation of the applicable metal conduit (JIS C 8305)

Pole Mount (for TIIS certified model only)

Packing Type Cable Lead-in Fitting

Only one cable can be lead in.



Three different packings are available for 1-, 2-, and 3-column.

Material: Brass (nickel-plated)

Box Style	Part No.	Packing	Cable Diameter D (mm)	Symbol
1 column	EC9E-S10	R12	$\phi 8 \leq D \leq \phi 12$	SF
		R16	$\phi 12 < D \leq \phi 16$	
		R20	$\phi 16 < D \leq \phi 20$	
2, 3 column	EC9E-S20	R18	$\phi 14 \leq D \leq \phi 18$	
		R22	$\phi 18 < D \leq \phi 22$	
		R26	$\phi 22 < D \leq \phi 26$	

Flameproof Packing Type Cable Lead-in Fittings (for TIIS certified model only)

Used to lead in rubber and plastic cables.

Material: Brass (nickel-plated)



Flameproof packing type cable lead-in fitting	Applicable cable diameter D (mm)	Symbol	Dimensions (mm)		
			A	B	L
HPN21 R8	$\phi 6 \leq D \leq \phi 8$	H1	36	G1/2 (16)	67 to 70.5
HPN21 R10	$\phi 8 < D \leq \phi 10$	H2			
HPN21 R12	$\phi 10 < D \leq \phi 12$	H3			
HPN22 R14	$\phi 12 < D \leq \phi 14$	H4	40	G3/4 (22)	67 to 70.5
HPN22 R16	$\phi 14 < D \leq \phi 16$	H5			
HPN33 R18	$\phi 16 < D \leq \phi 18$	H6	50	G1 (28)	77.5 to 81
HPN33 R20	$\phi 18 < D \leq \phi 20$	H7			
HPN44 R23	$\phi 20 < D \leq \phi 23$	HA	58	G1 1/4 (36)	80.5 to 84
HPN44 R26	$\phi 23 < D \leq \phi 26$	HB			

- HPN44 cannot be used for 1, 2, or 3 control units/1 column.
- The dimension of B in () is the nominal designation of the applicable metal conduit. (JIS C 8305)
- When ordering TIIS certified model, specify the part no. of flameproof packing type cable lead-in fitting.

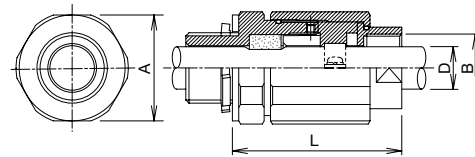

* For IECEX/ATEX/Ex-CCC, UL/c-UL certified control boxes, use cable lead-in fittings that are commercially available.

Terminal Blocks

A terminal block is not supplied with the standard control boxes (without wiring). When wiring inside the control box is required, specify the wiring circuit.

The terminal block type used on the control boxes with wiring depends on the terminal style of the control unit.

C terminal style (exposed screw terminal)

[Applicable terminal block]

Screw terminal: ET2A-8PE (material: polyamide)

Certification numbers:

IECEX TUR 15.0043U

TÜV 15 ATEX 7799U

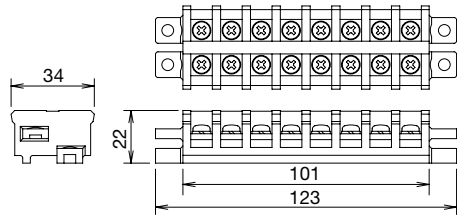

All dimensions in mm.

F terminal style (finger-safe screw terminal)

[Applicable terminal block]

IP20 clamp terminal: 264-238 (WAGO) (material: polyamide)

Certification numbers:

IECEX PTB 04.0003U

PTB 98 ATEX 3129U

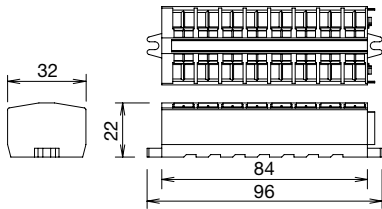

All dimensions in mm.

The number of terminal blocks, poles, and the installation direction that can be installed on the control box are as follows:

1-column 1, 2 units
(1 terminal block/
8 poles)



1-column 3 units
(1 terminal block/
8 poles)

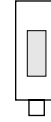

1-column 4, 5 units
(1 terminal block/
8 poles)



2-column 2, 3 units
(2 terminal blocks/
16 poles)

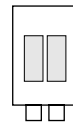

2-column 4,5 units
(4 terminal blocks/
32 poles)

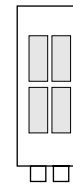

3-column 2, 3 units
(3 terminal blocks/
24 poles)



3-column 4, 5, 6 units
(6 terminal blocks/
48 poles)

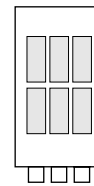

4-column 6 units
(8 terminal blocks/
64 poles)

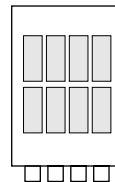

Dimensions

1, 2 Control Units × 1 Column

* Pole mount: TIIS certified model only

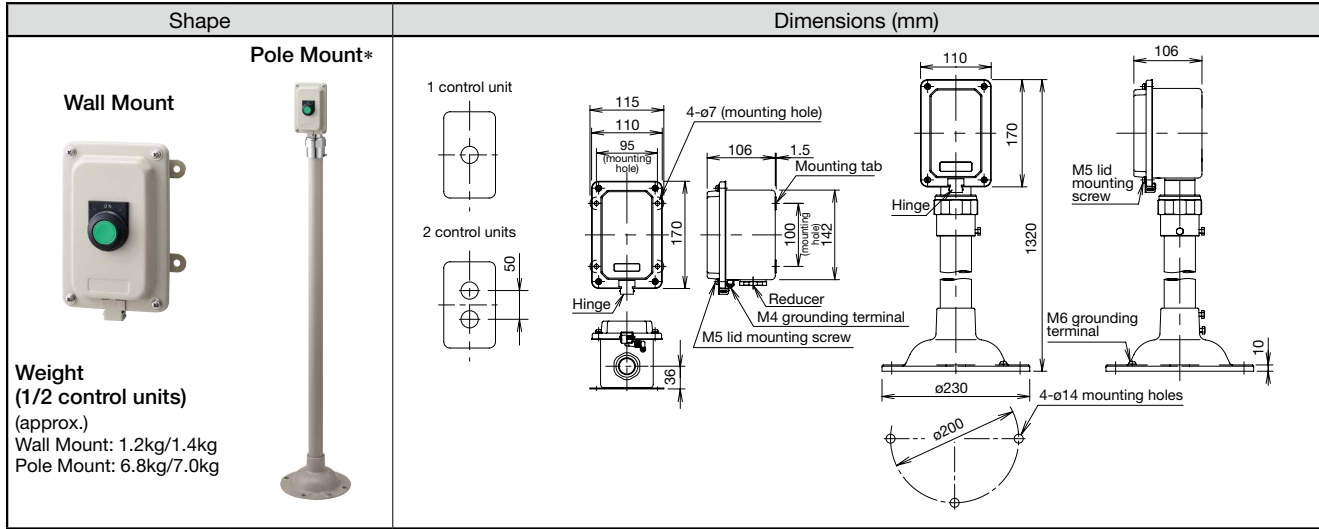

3 Control Units × 1 Column

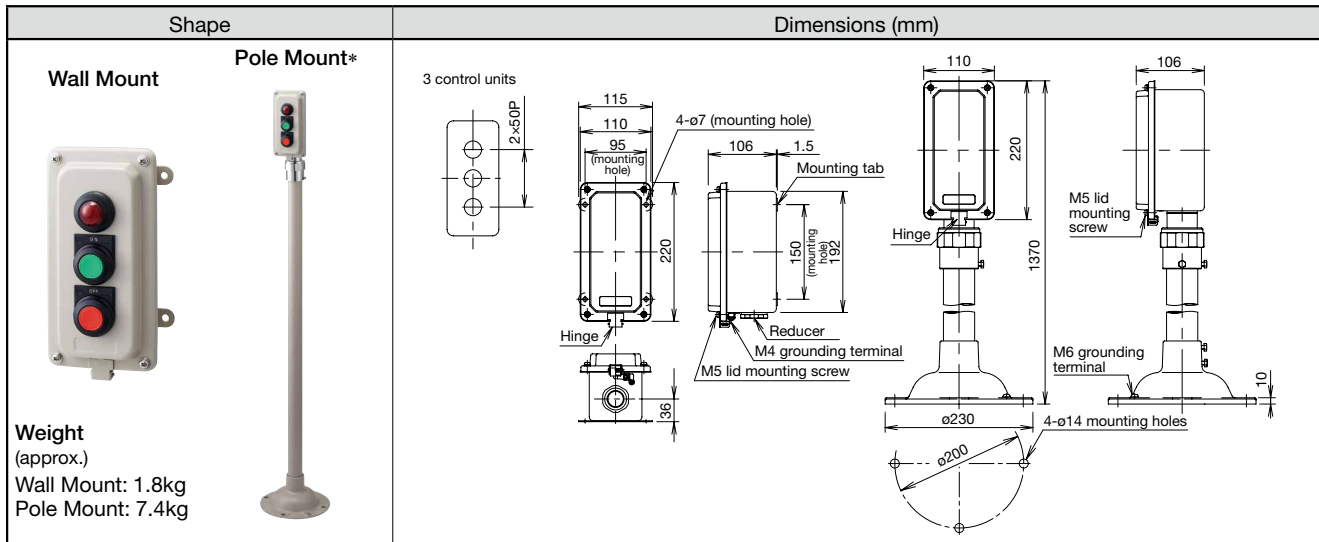

4, 5 Control Units × 1 Column

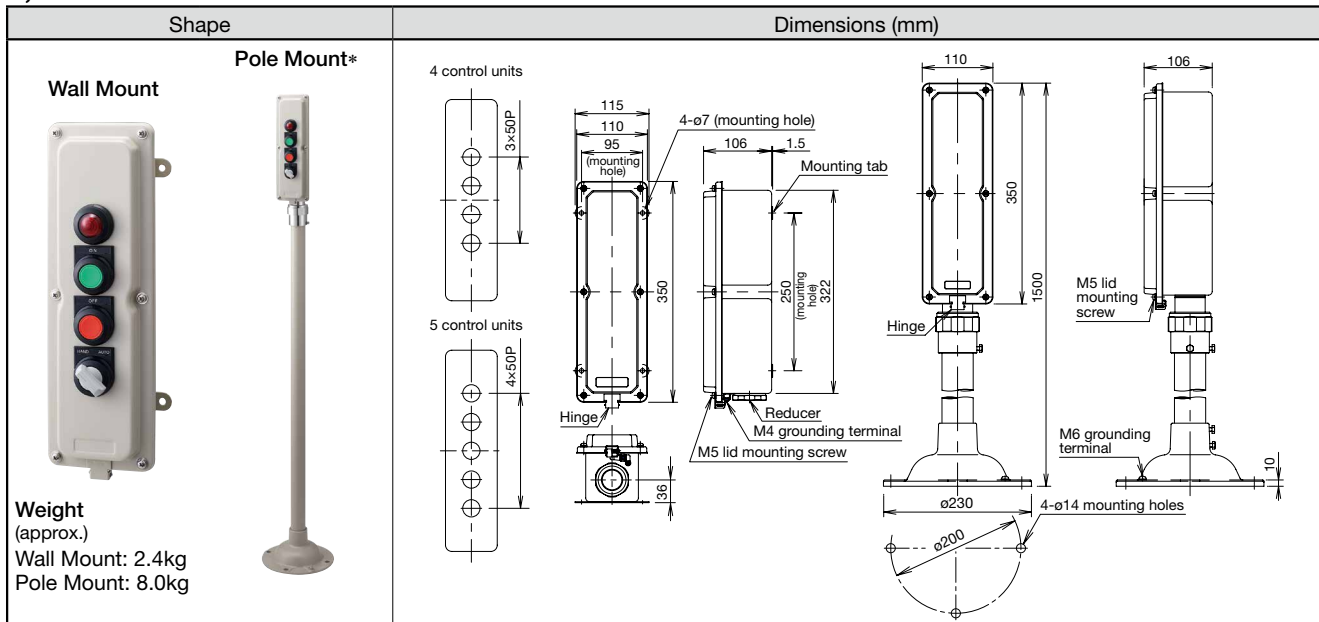

2, 3, 4, 5 control units × 2 Columns

* Pole mount: TIIS certified model only

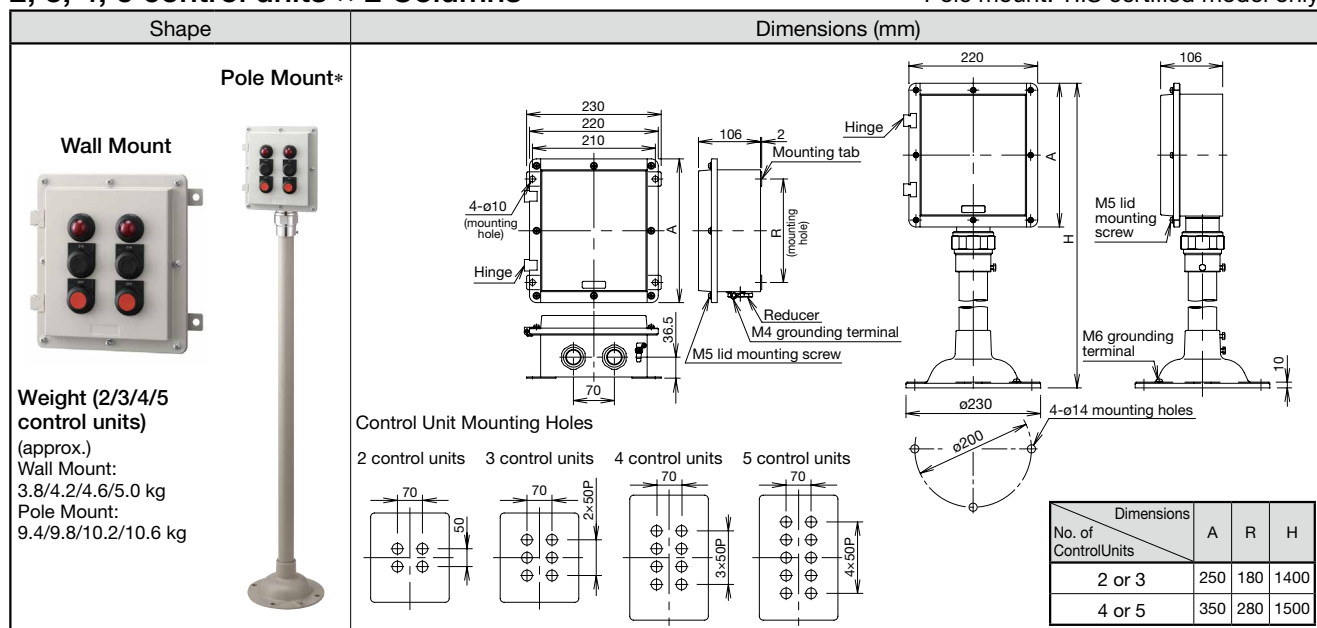

2, 3, 4, 5 control units × 3 Columns

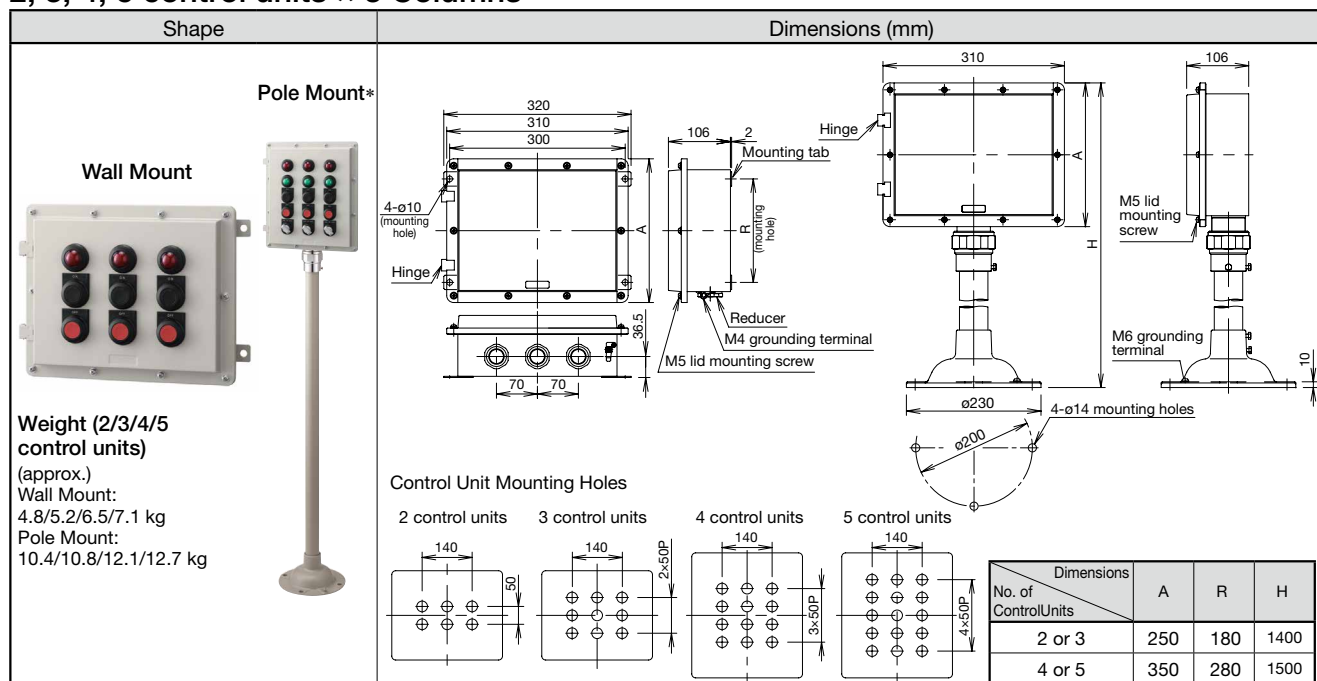

6 control units × 3 columns

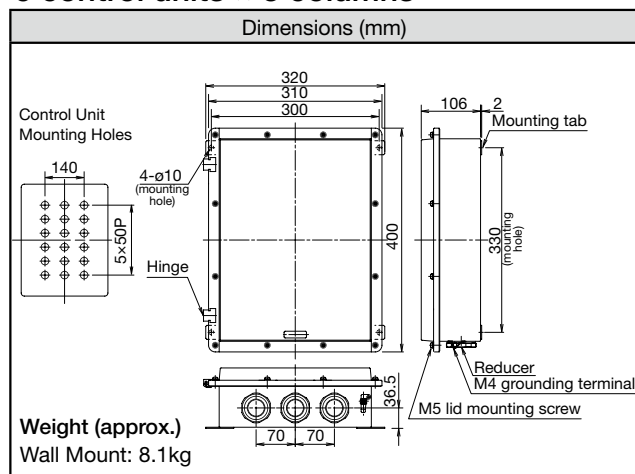



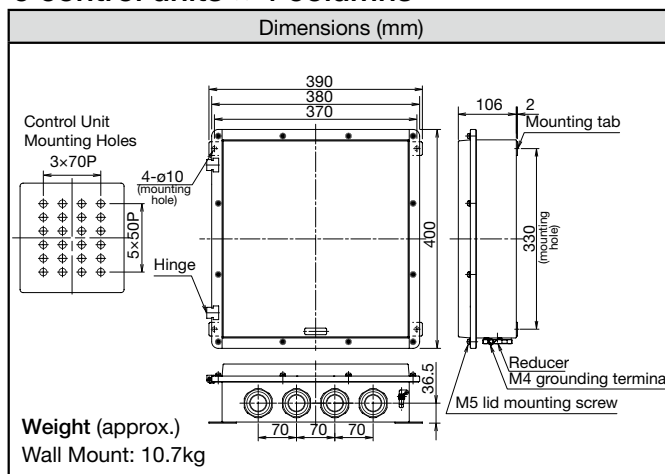



6 control units × 4 columns



Control Units

Applicable Standards

Control Units	Applicable Standards	Mark	Certification No.
Pushbuttons Selector Switches Key Selector Switches Pilot Lights Meters (EU2B-YM)	GB 12476.1 GB 12476.5 GB 3836.1 GB 3836.2 GB 3836.3		2021012304363041 2021012304363046 2021012309370228 2021012313363039
	EN60947-5-1		EU Low Voltage Directive
	UL60079-0 UL60079-1 UL60079-7		E347230
	CAN/CSA C22.2 No. 60079-0 CAN/CSA C22.2 No. 60079-1 CAN/CSA C22.2 No. 60079-7		
	EN60079-0 EN60079-1 EN60079-7 EN60079-31		PTB 08 ATEX 1053U PTB 08 ATEX 1003U
IEC60079-0 IEC60079-1 IEC60079-7 IEC60079-31		IECEx PTB 15.0006U IECEx PTB 15.0007U	
Emergency Stop Switches	EN60947-5-5		

Pilot Light Specifications

Rated Insulation Voltage (Ui)	500V
Rated Operating Voltage (Ue)	6, 12, 24V AC/DC
	100/110, 115, 120, 200/220 230, 240, 380, 400/440, 480V AC
Impulse Withstand Voltage (Uimp)	4kV
Insulation Resistance	100 MΩ minimum (500V DC)
Frequency	50/60Hz
Power Consumption (approx.)	0.3W (24V AC/DC)
	1.5W (100/110V AC)
Life (reference value)	Approx. 40,000 hours

- Because the built-in LED lamp is a high-luminance type, the lamp may light dimly due to induction even when the power is off.

Switch Specifications

Contact Resistance	50mΩ maximum (initial value)	
Impulse Withstand Voltage (Uimp)	6kV	
Insulation Resistance	100MΩ minimum (500V DC megger)	
Short-circuit Protection	250V/10A fuse (Type aM IEC60269-1/IEC60269-2)	
Conditional Short-circuit Current	1,000A	
Mechanical Life	Pushbutton	1,000,000 operations minimum
	Selector Switch	500,000 operations minimum
	Key Selector Switch	500,000 operations minimum
	Emergency Stop Switch	50,000 operations minimum
Electrical Life	Pushbutton	250,000 operations minimum (switching frequency 1800 operations/h)
	Selector Switch	250,000 operations minimum (switching frequency 900 operations/h)
	Key Selector Switch	250,000 operations minimum (switching frequency 900 operations/h)
	Emergency Stop Switch	50,000 operations minimum (switching frequency 900 operations/h)
Minimum Force Required for Direct Action	Emergency Stop Switch	60N
Minimum Operator Stroke Required for Direct Opening Action	Emergency Stop Switch	7.0mm
Maximum Operator Stroke	Emergency Stop Switch	9.0mm

- Contact bounce
Contacts will bounce during operation of pushbuttons and selector switches (reference value: 20 ms). Be sure to take contact bounce time into consideration when designing a control circuit.
- Replacing the control units, nameplates, padlock covers, and LED lamps by users affect the explosion-proof performance which is not guaranteed. Contact IDEC when replacement is necessary.

Contact Ratings

IECEx/ATEX/Ex-CCC, TIIS certified

Rated Insulation Voltage (Ui)		600V				
Rated Thermal Current (Ith)		10A (*)				
Rated Operating Voltage (Ue)		24V	120V	240V	500V	
Rated Operating Current (Ie)	AC 50/60Hz	Resistive Load (AC12)	10A (*)	10A (*)	6A	2.8A
		Inductive Load (AC15)	10A (*)	6A	3A	1.4A
	DC	Resistive Load (DC12)	8A	2.2A	1.1A	—
		Inductive Load (DC13)	4A	1.1A	0.55A	—

- * Up to 2 contacts (per control unit): 10A
3 contacts (per control unit): 9A
Minimum applicable load: 3V AC/DC, 5 mA
- Applicable operating locations may vary according to operating conditions and load types.
- TÜV ratings (emergency stop switches)
AC-15 250V/3A
DC-13 125V/1.1A
- UL/c-UL ratings: 600V/10A

Buzzer Specifications (EC9F-Z)

Rated Insulation Voltage (Ui)	250V
Rated Operation Voltage	110V AC, 220V AC (50/60Hz)
Time Rating	10 minutes
Sound Pressure (at 1m)	80dB minimum
Power	8VA maximum

- If the sound continues longer than the time rating, the internal parts may overheat and explosion-proof characteristics may be impaired.

Variable Resistor Specifications (EC9E-R)

Rated Power	1W or 2.5W (at 40°C)
Resistance Range	1, 2, 3, 5, 10kΩ Tolerance: ±10%, Characteristics: Linear
Insulation Resistance	100MΩ minimum (500V DC meggar)

- To maintain stable performance for a long period of time, use only up to about 50% of the rated power capacity.
- The variable resistor is available on control boxes with wiring.

Meter Specifications (EU2B-YM/EC9F-M)

Accuracy Class		2.5 (JIS)
Insulation Resistance		100 MΩ minimum (500V DC megger)
AC Ammeter	Rated Insulation Voltage (Ui)	300V
	Operation	Moving core
	Impulse Withstand Voltage (Uimp)	4kV
	Power Consumption	1VA
	Measurement	5A, 10A, 30A, 50A, etc
	Input (CT Ratio)	1A, 5A
Extended Memory		3 times, etc
DC Ammeter	Rated Insulation Voltage (Ui)	150V
	Operation	Moving coil
	Impulse Withstand Voltage (Uimp)	2.5kV
	Input	0 to 10V DC, 4 to 20mA DC, etc
	Power Consumption (DC ammeter)	0.01W
	Power Consumption (DC voltmeter)	1mA

- Use a commercially available CT (current transformer) for AC ammeters with consumption current of 10A minimum. Install the CT in a non-hazardous location.
- AC and DC ammeters other than listed above are also available upon request, such as extended scale or red pointer.

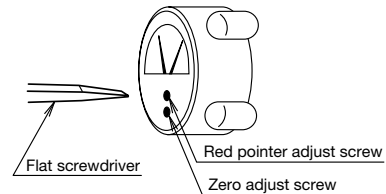

Pointer Zero Adjustment and Red Pointer Adjustment

- Using a flat screwdriver, turn the zero adjustment pointer screw and the red pointer screw (see below).
- Zero adjustment is possible only on AC ammeters. On other meters such as DC voltmeters, DC ammeters, and tachometer, zero adjustment is not possible.

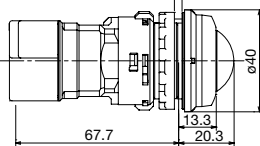
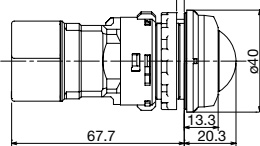
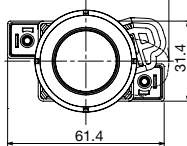

Control Units

Pilot Lights

Shape	Symbol	Contact Rating	Part No.		Illumination Color Code *	Weight (approx.)
			C terminal style: exposed screw terminal	F terminal style: finger-safe screw terminal		
	Ⓟ	100/110V AC 50/60Hz	EU2B-YL116CD*□	EU2B-YL116FD*□	R: red G: green A: amber Y: yellow W: white S: blue PW: pure white	150g
		200/220V AC 50/60Hz	EU2B-YL126CD*□	EU2B-YL126FD*□		108g
		24V AC/DC	EU2B-YL122CD*□	EU2B-YL122FD*□		
Dimensions (mm) <div style="display: flex; justify-content: space-around;"> <div style="text-align: center;"> <p>C Terminal Style Panel Thickness 1 to 4.5</p>  </div> <div style="text-align: center;"> <p>F Terminal Style Panel Thickness 1 to 4.5</p>  </div> <div style="text-align: center;">  </div> </div> <div style="text-align: right; margin-top: 10px;">  X1 X2 (All dimensions in mm.) </div>						

• Other voltages are available: 6V AC/DC, 12V AC/DC, 115V AC, 120V AC, 230V AC, 240V AC, 380V AC, 400/440V AC, 480V AC, 100/110/120V AC/DC, 230/240V AC/DC. For details, see [page 18](#).

- Because LED illuminated pilot lights have small input currents, they may light due to induction even when the power is off.
- Specify an illumination color code in place of * in the Part No.
- Specify the reducer certification code in place of □. -T: TIIS certified, Blank: IECEx/ATEX/Ex-CCC, UL/c-UL certified

Pushbuttons

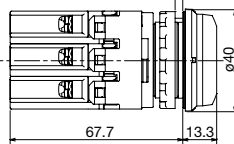
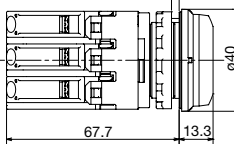
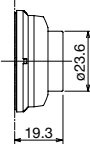
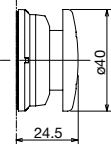
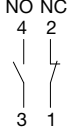
Shape	Symbol	Operation	Operator	Contact Arrangement	Part No.		Button Color Code	Weight (approx.)
					C terminal style: exposed screw terminal	F terminal style: finger-safe screw terminal		
	Ⓟ	Momentary	Flush	1NO	EU2B-YB110C*□	EU2B-YB110F*□	Blank: supplied with four buttons (B, G, R, W) Y: yellow S: blue	68g
				1NC	EU2B-YB101C*□	EU2B-YB101F*□		92g
				1NO-1NC	EU2B-YB111C*□	EU2B-YB111F*□		
			Extended	1NO	EU2B-YB210C*□	EU2B-YB210F*□	B: black G: green R: red W: white Y: yellow S: blue	70g
				1NC	EU2B-YB201C*□	EU2B-YB201F*□		94g
				1NO-1NC	EU2B-YB211C*□	EU2B-YB211F*□		
			Mush-room	1NO	EU2B-YB310C*□	EU2B-YB310F*□	76g	
				1NC	EU2B-YB301C*□	EU2B-YB301F*□		
				1NO-1NC	EU2B-YB311C*□	EU2B-YB311F*□		101g
Dimensions (mm) <div style="display: flex; justify-content: space-around;"> <div style="text-align: center;"> <p>Flush (C Terminal Style) Panel Thickness 1 to 4.5</p>  </div> <div style="text-align: center;"> <p>Flush (F Terminal Style) Panel Thickness 1 to 4.5</p>  </div> <div style="text-align: center;"> <p>Extended</p>  </div> <div style="text-align: center;"> <p>Mushroom</p>  </div> </div> <div style="text-align: right; margin-top: 10px;">  NO NC 4 2 3 1 (All dimensions in mm.) </div>								

• Other contact arrangements (2NO, 2NC, 1NO-2NC, 2NO-1NC, 3NO, 3NC) are also available. See [page 18](#).

- Specify a button color code in place of * in the Part No.
- Specify the reducer certification code in place of □. Blank: TIIS certified, -D: IECEx/ATEX/Ex-CCC, UL/c-UL certified

Emergency Stop Switches

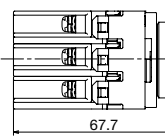
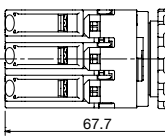
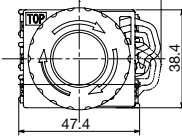
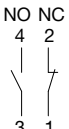
Shape	Symbol	Operation	Operator	Contact Arrangement	Part No.		Button color	Weight (approx.)
					C terminal style: exposed screw terminal	F terminal style: finger-safe screw terminal		
	Ⓟ	Push-to-lock or Turn-to-reset	ø40 Mushroom	2NC	EU2B-YBV302CR	EU2B-YBV302FR	Red	120g
				1NO-2NC	EU2B-YBV312CR	EU2B-YBV312FR		144g
				3NC	EU2B-YBV303CR	EU2B-YBV303FR		
Dimensions (mm) <div style="display: flex; justify-content: space-around;"> <div style="text-align: center;"> <p>C Terminal Style Panel Thickness 1 to 4.5</p>  </div> <div style="text-align: center;"> <p>F Terminal Style Panel Thickness 1 to 4.5</p>  </div> <div style="text-align: center;">  </div> </div> <div style="text-align: right; margin-top: 10px;">  NO NC 4 2 3 1 (All dimensions in mm.) </div>								

- Other contact arrangements (1NC, 1NO-1NC) are also available. See [page 18](#) for details.
- Emergency stop switches are only available with a red button.

Selector Switches

NC contact: direct opening action (IEC 60947-5-1 Annex K)

Shape	Symbol	No. of Positions	Contact Block		Operator Position		Operation	Part No.		Weight (approx.)	
			Mounting Position	Contact	1	2		C terminal style: exposed screw terminal	F terminal style: finger-safe screw terminal		
	ES	2-position 90°	①	NO		●	Maintained L R	EU2B-YS211C	EU2B-YS211F	98g	
			②	—							
			③	NC	●						
		3-position 45°				1	0	2			
			①	NO	●			Maintained L C R	EU2B-YS320C		EU2B-YS320F
			②	—							
③	NO		●								

Dimensions (mm)

C Terminal Style
Panel Thickness 1 to 4.5

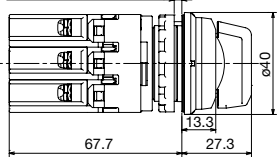

67.7 27.3 13.3 64.0

F Terminal Style
Panel Thickness 1 to 4.5

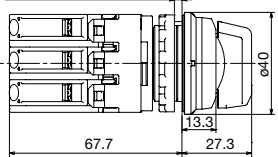

67.7 27.3 13.3 64.0

-GL, -UL

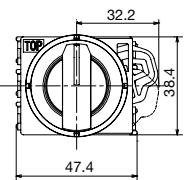

32.2 38.4 47.4

Operator Position

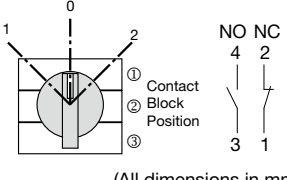

0
1 2
① Contact Block Position
②
③

NO NC
4 2
3 1

(All dimensions in mm.)

- Other contact arrangements (2NO, 2NC, 1NO-2NC, 2NO-1NC, 3NO, 3NC) and overlapping contacts are also available.
- Spring return from right, spring return from left, spring return two-way also available. See pages 19 to 20.

Key Selector Switches

NC contact: direct opening action (IEC 60947-5-1 Annex K)

Shape	Symbol	No. of Positions	Contact Block		Operator Position		Operation	Part No.		Weight (approx.)	
			Mounting Position	Contact	1	2		C terminal style: exposed screw terminal	F terminal style: finger-safe screw terminal		
	ES	2-position 90°	①	NO		●	Maintained L R	EU2B-YSK211CA	EU2B-YSK211FA	120g	
			②	—							
			③	NC	●						
		3-position 45°				1	0	2			
			①	NO	●			Maintained L C R	EU2B-YSK320CA		EU2B-YSK320FA
			②	—							
③	NC		●								

Dimensions (mm)

C Terminal Style
Panel Thickness 1 to 4.5

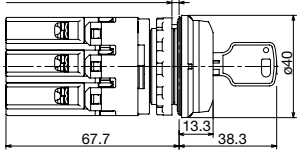

67.7 13.3 38.3 64.0

F Terminal Style
Panel Thickness 1 to 4.5

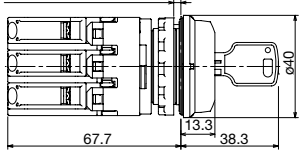

67.7 13.3 38.3 64.0

-GL, -UL

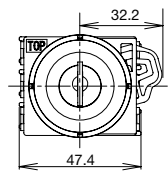

32.2 47.4

Operator Position

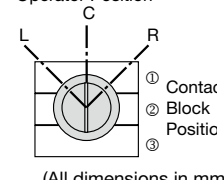

C
L R
① Contact Block Position
②
③

(All dimensions in mm.)

- Other contact arrangements (2NO, 2NC, 1NO-2NC, 2NO-1NC, 3NO, 3NC) and overlapping contacts are also available.
- Spring return from right, spring return from left, spring return two-way also available.
- On the spring-returned, the key can released only from the maintained position. On the maintained, the key can be released from every position.
- Key retained position can be selected. See pages 19 to 20.
- Each key selector switch is supplied with two identical keys. Three different keys are also available.

Buzzer (for TIIS certified model only) (Cannot be installed on 1 to 3 units × 1 column boxes.)

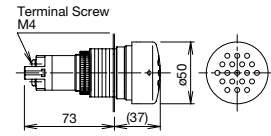
Shape	Symbol	Rated Power (50/60Hz)	Part No.	Sound Volume (at 1m)	Sound Duration	Power Consumption	Weight (approx.)	Dimensions
	EZ	110V AC	EC9F-Z11N	80dB minimum	10 minutes *	8VA maximum	0.4kg	 <p>Terminal Screw M4 73 (37) 65.0</p> <p>No finger-safe screw terminal model available.</p>
		220V AC	EC9F-Z12N					

* Do not exceed the sound duration time, otherwise internal heating will result.

Variable Resistors (for TIIS certified model only) (Cannot be installed on 1 to 5 units × 1 column boxes.)

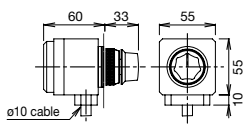
Shape	Symbol	Resistance Range	Part No.	Rated Power	Insulation Resistance	Weight (approx.)	Dimensions (mm)
	Ⓜ	1, 2, 3, 5, 10kΩ Tolerance±10% Characteristics: linear	EC9E-R	1W, 2.5W (at 40°C)	100MΩ minimum (500V DC)	0.45kg	

- The variable resistor is available on control boxes with wiring.
- Specify resistance value and rated power when ordering.

Meters (IECEX/ATEX/Ex-CCC, UL/c-UL Certified)

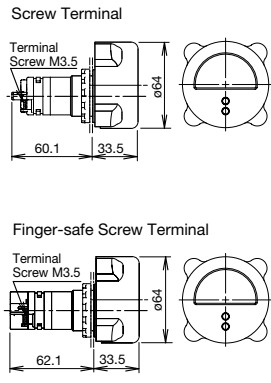
Shape	Symbol	Input	Part No.	Specifications	Capacity/ Scale Code	Weight (approx.)	Dimensions (mm)
	Ⓜ	AC input meter (ammeter)	EU2B-YM53A5△	Capacity: 5A Expansion scale ×3	5A (3)	0.3kg	
			EU2B-YM53A10△	Capacity: 10/5A Expansion scale ×3	10/5A (3)		
			EU2B-YM13A10△	Capacity: 10/1A Expansion scale ×3	10/1A (3)		
			EU2B-YM53A15△	Capacity: 15/5A Expansion scale ×3	15/5A (3)		
			EU2B-YM13A15△	Capacity: 15/1A Expansion scale ×3	15/1A (3)		
			EU2B-YM13A20△	Capacity: 20/1A Expansion scale ×3	20/1A (3)		
			EU2B-YM53A30△	Capacity: 30/5A Expansion scale ×3	30/5A (3)		
			EU2B-YM13A30△	Capacity: 30/1A Expansion scale ×3	30/1A (3)		
			EU2B-YM53A50△	Capacity: 50/5A Expansion scale ×3	50/5A (3)		
			EU2B-YM53A60△	Capacity: 60/5A Expansion scale ×3	60/1A (3)		
			EU2B-YM53A75△	Capacity: 75/5A Expansion scale ×3	75/5A (3)		
			EU2B-YM53A100△	Capacity: 100/5A Expansion scale ×3	100/5A (3)		
		EU2B-YM53A150△	Capacity: 150/5A Expansion scale ×3	150/5A (3)			
		DC input meter	EU2B-YM010VD△-PER	0-10V DC input Scale: 0 to 100%	010VD-PER		
			EU2B-YM010VD△-60HZ	0-10V DC input Scale: 0 to 60Hz	010VD-60HZ		
			EU2B-YM001MD△-PER	0-1mA DC input Scale: 0 to 100%	001MD-PER		
			EU2B-YM001MD△-60HZ	0-1mA DC input Scale: 0 to 60Hz	001MD-60HZ		
			EU2B-YM001MD△-80HZ	0-1mA DC input Scale: 0 to 80Hz	001MD-80HZ		
EU2B-YM420MD△-PER	4-20mA DC input Scale: 0 to 100%		420MD-PER				
EU2B-YM420MD△-60HZ	4-20mA DC input Scale: 0 to 60Hz	420MD-60HZ					

- Specify a terminal style in place of △ in the Part No. C: exposed screw terminal), F: finger-safe screw terminal
- Use a commercially available CT (current transformer) for AC ammeters with consumption current of 10A minimum. Install the CT in a non-hazardous location.
- AC and DC ammeters other than listed above are also available upon request.

Meters (TIIS certified model only) (Cannot be installed on 1 to 3 units × 1 column boxes.)

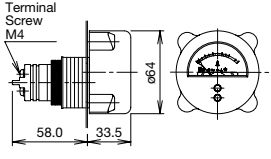
Shape	Symbol	Input	Part No.	Specifications	Weight (approx.)	Dimensions (mm)
	Ⓜ	AC input meter (ammeter)	EC9F-M53A5N	Capacity: 5A Expansion scale ×3	0.3kg	
			EC9F-M53A10N	Capacity: 10/5A Expansion scale ×3		
			EC9F-M13A10N	Capacity: 10/1A Expansion scale ×3		
			EC9F-M53A15N	Capacity: 15/5A Expansion scale ×3		
			EC9F-M13A15N	Capacity: 15/1A Expansion scale ×3		
			EC9F-M13A20N	Capacity: 20/1A Expansion scale ×3		
			EC9F-M53A30N	Capacity: 30/5A Expansion scale ×3		
			EC9F-M13A30N	Capacity: 30/1A Expansion scale ×3		
			EC9F-M53A50N	Capacity: 50/5A Expansion scale ×3		
			EC9F-M53A60N	Capacity: 60/5A Expansion scale ×3		
			EC9F-M53A75N	Capacity: 75/5A Expansion scale ×3		
			EC9F-M53A100N	Capacity: 100/5A Expansion scale ×3		
		EC9F-M53A150N	Capacity: 150/5A Expansion scale ×3			
		DC input meter	EC9F-M010VD-PER	0-10V DC input Scale: 0 to 100%		
			EC9F-M010VD-60HZ	0-10V DC input Scale: 0 to 60Hz		
			EC9F-M01MD-PER	0-1mA DC input Scale: 0 to 100%		
			EC9F-M01MD-60HZ	0-1mA DC input Scale: 0 to 60Hz		
			EC9F-M01MD-80HZ	0-1mA DC input Scale: 0 to 80Hz		
EC9F-M420MD-PER	4-20mA DC input Scale: 0 to 100%					
EC9F-M420MD-60HZ	4-20mA DC input Scale: 0 to 60Hz					

- Use a commercially available CT (current transformer) for AC ammeters with consumption current of 10A minimum. Install the CT in a non-hazardous location.
- AC and DC ammeters other than listed above are also available upon request.

Available Control Units

Pilot Lights

Input	Rated Voltage	Part No.		Illumination Color Code *
		Exposed Screw Terminal	Finger-safe Screw Terminal	
AC	100/110V AC	EU2B-YL116CD*□	EU2B-YL116FD*□	R: red G: green A: amber Y: yellow W: white S: blue PW: pure white
	115V AC	EU2B-YL1116CD*□	EU2B-YL1116FD*□	
	120V AC	EU2B-YL1126CD*□	EU2B-YL1126FD*□	
	200/220V AC	EU2B-YL126CD*□	EU2B-YL126FD*□	
	230V AC	EU2B-YL1236CD*□	EU2B-YL1236FD*□	
	240V AC	EU2B-YL1246CD*□	EU2B-YL1246FD*□	
	380V AC	EU2B-YL1386CD*□	EU2B-YL1386FD*□	
	400/440V AC	EU2B-YL146CD*□	EU2B-YL146FD*□	
AC/DC	480V AC	EU2B-YL1486CD*□	EU2B-YL1486FD*□	
	6V AC/DC	EU2B-YL166CD*□	EU2B-YL166FD*□	
	12V AC/DC	EU2B-YL111CD*□	EU2B-YL111FD*□	
	24V AC/DC	EU2B-YL122CD*□	EU2B-YL122FD*□	
	100/110/120V AC/DC (Note 1)	EU2B-YL1110CD*□	EU2B-YL1110FD*□	

- Specify a color code in place of * in the Part No.
 - Specify the reducer certification code in place of □. -T: TIIS certified, Blank: IECEx/ATEX/Ex-CCC, UL/c-UL certified
- Note 1: For IECEx/ATEX/Ex-CCC, UL/c-UL

Pushbuttons

Operator	Operation	Contact Arrangement	Part No.		Button Color Code *
			Exposed Screw Terminal	Finger-safe Screw Terminal	
Flush	Momentary	1NO	EU2B-YB110C*□	EU2B-YB110F*□	Blank: supplied with B (black), G (green), R (red) and W (white) buttons. Y: yellow S: blue
		1NC	EU2B-YB101C*□	EU2B-YB101F*□	
		1NO-1NC	EU2B-YB111C*□	EU2B-YB111F*□	
		2NO	EU2B-YB120C*□	EU2B-YB120F*□	
		2NC	EU2B-YB102C*□	EU2B-YB102F*□	
		2NO-1NC	EU2B-YB121C*□	EU2B-YB121F*□	
		1NO-2NC	EU2B-YB112C*□	EU2B-YB112F*□	
		3NO	EU2B-YB130C*□	EU2B-YB130F*□	
Extended	Momentary	3NC	EU2B-YB103C*□	EU2B-YB103F*□	B: black G: green R: red W: white Y: yellow S: blue
		1NO	EU2B-YB210C*□	EU2B-YB210F*□	
		1NC	EU2B-YB201C*□	EU2B-YB201F*□	
		1NO-1NC	EU2B-YB211C*□	EU2B-YB211F*□	
		2NO	EU2B-YB220C*□	EU2B-YB220F*□	
		2NC	EU2B-YB202C*□	EU2B-YB202F*□	
		2NO-1NC	EU2B-YB221C*□	EU2B-YB221F*□	
		1NO-2NC	EU2B-YB212C*□	EU2B-YB212F*□	
ø40 Mushroom	Momentary	3NO	EU2B-YB230C*□	EU2B-YB230F*□	B: black G: green R: red W: white Y: yellow S: blue
		3NC	EU2B-YB203C*□	EU2B-YB203F*□	
		1NO	EU2B-YB310C*□	EU2B-YB310F*□	
		1NC	EU2B-YB301C*□	EU2B-YB301F*□	
		1NO-1NC	EU2B-YB311C*□	EU2B-YB311F*□	
		2NO	EU2B-YB320C*□	EU2B-YB320F*□	
		2NC	EU2B-YB302C*□	EU2B-YB302F*□	
		2NO-1NC	EU2B-YB321C*□	EU2B-YB321F*□	
ø40 Mushroom	Momentary	1NO-2NC	EU2B-YB312C*□	EU2B-YB312F*□	B: black G: green R: red W: white Y: yellow S: blue
		3NO	EU2B-YB330C*□	EU2B-YB330F*□	
		3NC	EU2B-YB303C*□	EU2B-YB303F*□	

- Specify a color code in place of * in the Part No.
- Specify explosion-proof certification code in place of □ in the Part No. -D: IECEx/ATEX/Ex-CCC, UL/u-CL, Blank: TIIS,

Emergency Stop Switches

Operator	Contact Arrangement	Part No.	
		Exposed Screw Terminal	Finger-safe Screw Terminal
ø40 Mushroom	1NC	EU2B-YBV301CR	EU2B-YBV301FR
	1NO-1NC	EU2B-YBV311CR	EU2B-YBV311FR
	2NC	EU2B-YBV302CR	EU2B-YBV302FR
	1NO-2NC	EU2B-YBV312CR	EU2B-YBV312FR
	3NC	EU2B-YBV303CR	EU2B-YBV303FR

- Emergency stop switches are only available with a red button.

Selector Switches (2-position)

No. of Positions	Contact Block		Operator Position		Part No.				△: Terminal
	Mounting Position	Contact	L	R	Selector Switch		Key Selector Switch		
					Maintained (90°)	Spring return from right (60°)	Maintained (90°)	Spring return from right (60°)	
90° 2-position/60° 2-position	①	NO		●					
	②				EU2B-YS210△	EU2B-YS2110△	EU2B-YSK210△◇	EU2B-YSK2110△B	
	③								
	①								
	②				EU2B-YS201△	EU2B-YS2101△	EU2B-YSK201△◇	EU2B-YSK2101△B	
	③	NC	●						
	①	NO		●					
	②				EU2B-YS220△	EU2B-YS2120△	EU2B-YSK220△◇	EU2B-YSK2120△B	
	③	NO		●					
	①	NC	●						
	②				EU2B-YS202△	EU2B-YS2102△	EU2B-YSK202△◇	EU2B-YSK2102△B	
	③	NC	●						
	①	NO		●					
	②				EU2B-YS211△	EU2B-YS2111△	EU2B-YSK211△◇	EU2B-YSK2111△B	
	③	NC	●						
	①	NO		●					
	②	NO		●	EU2B-YS230△	EU2B-YS2130△	EU2B-YSK230△◇	EU2B-YSK2130△B	
	③	NO		●					
	①	NC	●						
	②	NC	●		EU2B-YS203△	EU2B-YS2103△	EU2B-YSK203△◇	EU2B-YSK2103△B	
	③	NC	●						
	①	NO		●					
	②	NO		●	EU2B-YS221△	EU2B-YS2121△	EU2B-YSK221△◇	EU2B-YSK2121△B	
	③	NC	●						
①	NO		●						
②	NC	●		EU2B-YS212△	EU2B-YS2112△	EU2B-YSK212△◇	EU2B-YSK2112△B		
③	NC	●							
①	NO		■						
②				EU2B-YS2R11△	—	EU2B-YSK2R11△◇	—		
③	NC		■						

C: Exposed screw terminal
F: Finger-safe screw terminal

- Specify a terminal style in place of △ in the Part No. C: exposed screw terminal, F: finger-safe screw terminal
- Specify a key removable position code in place of ◇ in the Part No. See below for details.

Selector Switches (2-position/inverse cam)

No. of Positions	Contact Block		Operator Position		Part No.		△: Terminal
	Mounting Position	Contact	L	R	Selector Switch	Key Selector Switch	
					Maintained (90°)	Maintained (90°)	
90° 2-position	①	NO	●				
	②				EU2B-YS2J10△	EU2B-YSK2J10△◇	
	③						
	①						
	②				EU2B-YS2J01△	EU2B-YSK2J01△◇	
	③	NC		●			
	①	NO	●				
	②				EU2B-YS2J20△	EU2B-YSK2J20△◇	
	③	NO	●				
	①	NC		●			
	②				EU2B-YS2J02△	EU2B-YSK2J02△◇	
	③	NC		●			
	①	NO	●				
	②				EU2B-YS2J11△	EU2B-YSK2J11△◇	
	③	NC		●			
	①	NO	●				
	②	NO	●		EU2B-YS2J30△	EU2B-YSK2J30△◇	
	③	NO	●				
	①	NC		●			
	②	NC		●	EU2B-YS2J03△	EU2B-YSK2J03△◇	
	③	NC		●			
	①	NO	●				
	②	NO	●		EU2B-YS2J21△	EU2B-YSK2J21△◇	
	③	NC		●			
①	NO	●					
②	NC		●	EU2B-YS2J12△	EU2B-YSK2J12△◇		
③	NC		●				

C: Exposed screw terminal
F: Finger-safe screw terminal

Positions

(2-position, 2-position/inverse cam)

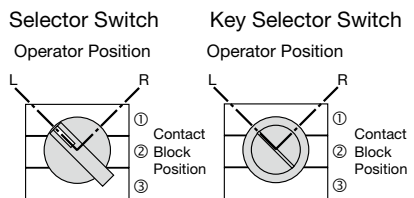

Key Removable Positions

(2-position, 2-position/inverse cam)

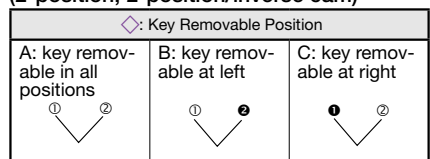

①②: Key removable
●●: Key retained

- Specify a terminal style in place of △ in the Part No. C: exposed screw terminal, F: finger-safe screw terminal
- Specify a key removable position code in place of ◇ in the Part No. See the details at right.

Selector Switches (3-position)

No. of Positions	Contact Block		Operator Position		Part No.								
	Mounting Position	Contact	1	0	Selector Switch				Key Selector Switch				
					Maintained 	Spring return from right 	Spring return from left 	Spring return two way 	Maintained 	Spring return from right 	Spring return from left 	Spring return two way 	
3-position	①	NO	●		EU2B-YS320△	EU2B-YS3120△	EU2B-YS3220△	EU2B-YS3320△	EU2B-YSK320△◇	EU2B-YSK3120△◇	EU2B-YSK3220△◇	EU2B-YSK3320△◇	
	②	NO		●									
	③	NO			●								
	①	NO	●	●		EU2B-YS320N1△	EU2B-YS3120N1△	EU2B-YS3220N1△	EU2B-YS3320N1△	EU2B-YSK320N1△◇	EU2B-YSK3120N1△◇	EU2B-YSK3220N1△◇	EU2B-YSK3320N1△◇
	②	NO	●										
	③	NO		●									
	①	NC		■		EU2B-YS302△	EU2B-YS3102△	EU2B-YS3202△	EU2B-YS3302△	EU2B-YSK302△◇	EU2B-YSK3102△◇	EU2B-YSK3202△◇	EU2B-YSK3302△◇
	②	NC			■								
	③	NC			■								
	①	NC	●			EU2B-YS302N1△	EU2B-YS3102N1△	EU2B-YS3202N1△	EU2B-YS3302N1△	EU2B-YSK302N1△◇	EU2B-YSK3102N1△◇	EU2B-YSK3202N1△◇	EU2B-YSK3302N1△◇
	②	NC		●									
	③	NC			●								
	①	NO	●			EU2B-YS311△	EU2B-YS3111△	EU2B-YS3211△	EU2B-YS3311△	EU2B-YSK311△◇	EU2B-YSK3111△◇	EU2B-YSK3211△◇	EU2B-YSK3311△◇
	②	NO											
	③	NC			■								
	①	NC		■		EU2B-YS311N1△	EU2B-YS3111N1△	EU2B-YS3211N1△	EU2B-YS3311N1△	EU2B-YSK311N1△◇	EU2B-YSK3111N1△◇	EU2B-YSK3211N1△◇	EU2B-YSK3311N1△◇
	②	NO			●								
	③	NO			●								
	①	NO	●			EU2B-YS311N2△	EU2B-YS3111N2△	EU2B-YS3211N2△	EU2B-YS3311N2△	EU2B-YSK311N2△◇	EU2B-YSK3111N2△◇	EU2B-YSK3211N2△◇	EU2B-YSK3311N2△◇
	②	NC		●									
	③	NO			●								
	①				●	EU2B-YS311N3△	EU2B-YS3111N3△	EU2B-YS3211N3△	EU2B-YS3311N3△	EU2B-YSK311N3△◇	EU2B-YSK3111N3△◇	EU2B-YSK3211N3△◇	EU2B-YSK3311N3△◇
	②	NC		●									
	③	NO			●								
①	NO	●	●		EU2B-YS311N4△	EU2B-YS3111N4△	EU2B-YS3211N4△	EU2B-YS3311N4△	EU2B-YSK311N4△◇	EU2B-YSK3111N4△◇	EU2B-YSK3211N4△◇	EU2B-YSK3311N4△◇	
②	NO	●											
③	NO		●										
①	NO	●			EU2B-YS330△	EU2B-YS3130△	EU2B-YS3230△	EU2B-YS3330△	EU2B-YSK330△◇	EU2B-YSK3130△◇	EU2B-YSK3230△◇	EU2B-YSK3330△◇	
②	NO	●											
③	NO		●										
①	NC		■		EU2B-YS303△	EU2B-YS3103△	EU2B-YS3203△	EU2B-YS3303△	EU2B-YSK303△◇	EU2B-YSK3103△◇	EU2B-YSK3203△◇	EU2B-YSK3303△◇	
②	NC			■									
③	NC			■									
①	NO	●			EU2B-YS321N1△	EU2B-YS3121N1△	EU2B-YS3221N1△	EU2B-YS3321N1△	EU2B-YSK321N1△◇	EU2B-YSK3121N1△◇	EU2B-YSK3221N1△◇	EU2B-YSK3321N1△◇	
②	NC		●										
③	NO			●									
①	NC		■		EU2B-YS312N1△	EU2B-YS3112N1△	EU2B-YS3212N1△	EU2B-YS3312N1△	EU2B-YSK312N1△◇	EU2B-YSK3112N1△◇	EU2B-YSK3212N1△◇	EU2B-YSK3312N1△◇	
②	NO	●											
③	NC			■									

- Specify a terminal style in place of △ in the Part No. C: exposed screw terminal), F: finger-safe screw terminal
- Specify a key removable position code in place of ◇ in the Part No. See below for details.

Key Removable Positions (2-position)

◇: Key Removable Position			
A: key removable in all positions 	B: key removable in right and center 	C: key removable at center and right 	D: key removable in center
E: key removable at left and right 	G: key removable at left 	H: key removable at right 	

Positions

(3-position)

Selector Switch

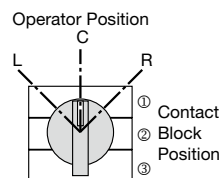

Key Selector Switch

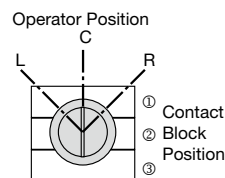

Spring return from right	Spring return from left	Spring return two-way

- ⓪ ① ②: Key removable
- ① ②: Key retained

Accessories

Plate Lock Padlock Cover

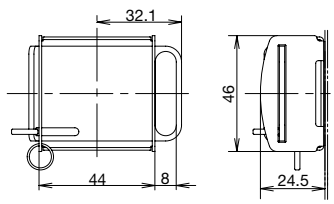
Shape	Part No.	Dimensions (mm)	Remarks
 Material: SUS304	EU9Z-PC		<ul style="list-style-type: none"> Used for the following purposes. EU2B-YB2 extended pushbutton: to maintain latched status EU2B-YB1 flush pushbutton/EU2B-YSK key selector switch: to prevent operation



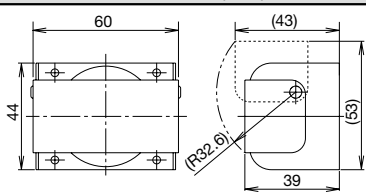

Pushbutton Cover

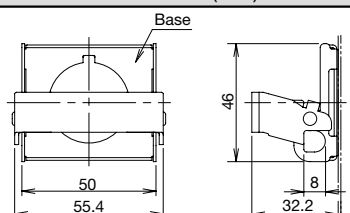
Shape	Part No.	Dimensions (mm)	Remarks
 Material: SUS304	EU9Z-BC		<ul style="list-style-type: none"> Used to protect the EU2B-YB pushbutton from inadvertent operation. Mounted by screwing on the control box and cannot be retrofit. Cannot be used for TIIS or UL/c-UL certified model.

Emergency Stop Switch Padlock Cover

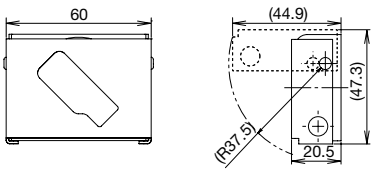
Shape	Part No.	Dimensions (mm)	Remarks
 Coating: yellow Material: SUS304	EU9Z-PCE		<ul style="list-style-type: none"> Used with EU2B-YBV emergency stop switch to maintain the switch in the latched status.

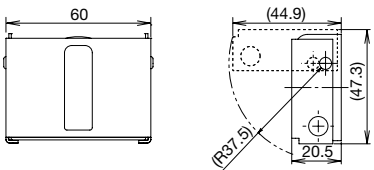

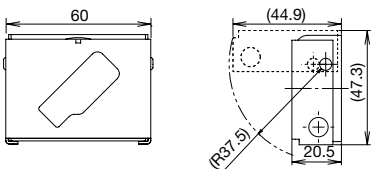
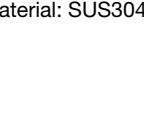
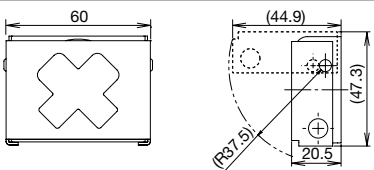







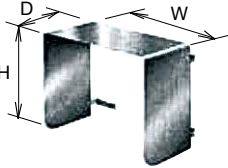





Selector Switch Padlock Cover

Shape	Part No.	Lock Position		Dimensions (mm)	Remarks
		2-position	3-position		
 EU9Z-PC21	EU9Z-PCS21	Left	Left		<ul style="list-style-type: none"> Used with EU2B-YS selector switch to maintain the switch in the selected lock status. Mounted by screwing on the control box and cannot be later. Cannot be used for TIIS or UL/c-UL certified model.
 EU9Z-PC30	EU9Z-PCS30	—	Center		
 EU9Z-PC22	EU9Z-PCS22	Right	Right		
 Material: SUS304	EU9Z-PCS2X	Left Right	Left Right		

Pushbutton Rubber Boots

Shape	Part No.	Button Type	For use with nameplate	Rubber boot on pushbutton	Remarks
 Material: Silicone rubber	EU9Z-DB1	Flush	No	 Flush pushbutton	<ul style="list-style-type: none"> • Used to protect the button of flush/extended pushbuttons. • Cannot be used on TIIS certified models.
 Material: Silicone rubber	EU9Z-DB1N	Flush	Yes		
 Material: Silicone rubber	EU9Z-DB2	Extended	No	 Extended pushbutton	
 Material: Silicone rubber	EU9Z-DB2N	Extended	Yes		

Control Box Shade

Shape	Part No.	Applicable Control Box	Dimensions (mm)		
			H	W	D
 Material: stainless steel Thickness: 1mm Photo: Part No. EC9Z-F2A52	EC9Z-F2A21M	EC2B-11  B	180	160	160
		EC2B-21  B			
	EC9Z-F2A31M	EC2B-31  B	230	160	160
	EC9Z-F2A51	EC2B-41  B	360	160	160
		EC2B-51  B			
	EC9Z-F2A32	EC2B-22  B	260	420	160
		EC2B-32  B			
	EC9Z-F2A52	EC2B-42  B	360	420	160
		EC2B-52  B			
	EC9Z-F2A33	EC2B-23  B	260	510	160
EC2B-33  B					
EC9Z-F2A53	EC2B-43  B	360	510	160	
	EC2B-53  B				
EC9Z-F2A63	EC2B-63  B	410	510	160	
EC9Z-F2A64	EC2B-64  B	410	580	160	



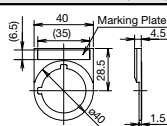

- Protects control units from direct sunlight and rain.
- The surface of the control box shade is uncoated.
- Can be installed by tightening to the mounting tabs on the control box.
- Control box shade cannot be installed later. Specify shade at time of order.

Nameplates

Control Unit Nameplates

Shape	Part No.	Dimensions (mm)	Remarks
	EU9Z-NM		<ul style="list-style-type: none"> Used for pilot light, pushbutton, selector switch, and key selector switch (only EU9Z-NP marking plates can be used on EU9Z-NM control unit nameplates).

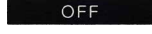
Marking Plates for Control Unit Nameplates

Shape	Legend	Part No.
	Blank	EU9Z-NP0
	ON	EU9Z-NP1
	OFF	EU9Z-NP2
	START	EU9Z-NP3
	STOP	EU9Z-NP4
	OFF-ON	EU9Z-NP31
	HAND-AUTO	EU9Z-NP35
	HAND-OFF-AUTO	EU9Z-NP53

Material: aluminum (35×6.5×1mm)
(White legends on black background)

- When other legends are needed, order blank nameplate and engrave.

Emergency Stop Switch Nameplate Sticker

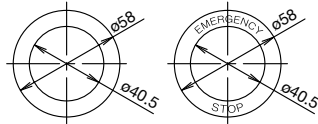
Shape	Legend	Part No.	Dimensions (mm)
 <p>Material: synthetic paper Background: yellow Legend: black</p>	① Blank ② EMERGENCY STOP	EU9Z-NVS0 EU9Z-NVS27	

Maintenance Parts

Lens

Shape	Color	Part No.
	Red	EU9Z-LR
	Green	EU9Z-LG
	Amber	EU9Z-LA
	Yellow	EU9Z-LY
	Blue	EU9Z-LS
	White	EU9Z-LW (*)

- * Used for W (white) and PW (pure white) illumination.

Buttons

Shape	Button Shape	Part No.	Button Color Code
	① Flush	HW1A-B1□	Specify a color code in place of □ in the Ordering No. B: black S: blue G: green W: white R: red Y: yellow
	② Extended	HW1A-B2□	
	③ ø40 Mushroom	HW1A-B4□	

Control Unit Mounting Hole Plug

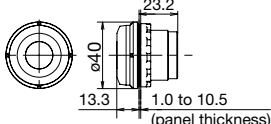
Shape	Part No.	Dimensions (mm)	Remarks
	EU9Z-BP		<ul style="list-style-type: none"> Used to plug unused mounting holes (ø30.5) on the mounting panel. See page 24 for TIIS certified mountable control boxes. Not mountable on 1 contact block type of -GL, -U models.

TIIS Certified Models

Box Size	Control Unit Configuration	No. of Mountable Control Units								No. of Units	Control Unit Terminal	TIIS Type Test Approval No.
		PL	PB	ES	SS	M	BZ	VR	BP			
11	01, 02	1	1	1	—	—	—	—	—	1	C	TC19254
	06	—	—	—	1	—	—	—	—		F	TC19255
		—	—	—	—	—	—	—	—		C	TC19256
	—	—	—	—	—	—	—	—	F		TC19257	
21	01, 02, 10	2	2	2	—	—	—	—	—	2	C	TC19254
		2	2	2	—	—	—	—	—		F	TC19255
	04	—	2	2	2	—	—	—	—		C	TC19256
		—	2	2	2	—	—	—	—		F	TC19257
	06, 17	2	—	—	2	—	—	—	—		C	TC19258
		2	—	—	2	—	—	—	—		F	TC19259
31	Any	3	3	3	3	—	—	—	—	3	C	TC19260
41		4	4	4	4	1	1	—	3	4	C/F	TC19262
51		5	5	5	5	1	1	—	4	5	C/F	
22		4	4	4	4	2	2	2	3	4	C/F	TC19263
32		6	6	6	6	2	2	2	5	6	C/F	
42		8	8	8	8	2	2	2	7	8	C/F	TC19264
52		10	10	10	10	2	2	2	9	10	C/F	
23		6	6	6	6	3	3	3	5	6	C/F	TC19265
33		9	9	9	9	3	3	3	8	9	C/F	
43		12	12	12	12	3	3	3	11	12	C/F	TC19266
53		15	15	15	15	3	3	3	14	15	C/F	
63		18	18	18	18	3	3	3	17	18	C/F	TC19267
64		24	24	24	24	4	4	4	23	24	C/F	TC19268

PL: Pilot lights (EU2B-YL), PB: Pushbuttons (EU2B-YB), ES: Emergency stop switches (EU2B-YBV), SS: Selector switches (EU2B-YS), Key Selector Switches (EU2B-YSK), M: Meter KS (EC9F-M), BZ: Buzzer (EC9F-Z), VR: Variable resistor (EC9E-R), BP: Control unit mounting hole plug (EU9Z-BP), —: not mountable

TIIS Certified Models Part No. Development

These part numbers are marked on TIIS certificate and product label, and not ordering no.

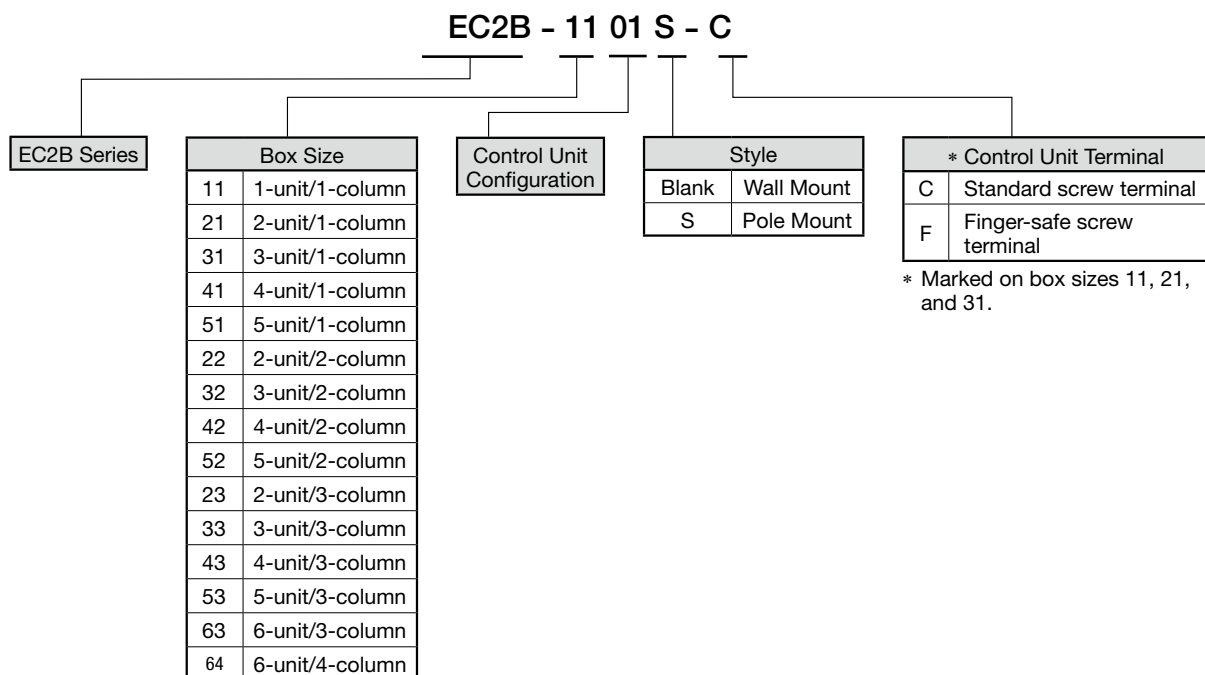

Safety Precautions

- Use explosion-proof electrical equipment that are applicable for use in hazardous areas (potentially explosive atmosphere where explosive gas or vapor may exist), otherwise explosion or fire hazard may result.
- EC2B control boxes can be installed only in zones 1 and 2. Do not use in zone 0. In North America, the EC2B can be installed in Division 2 areas, but cannot be installed in Division 1 areas.
- Turn power off to the EC2B control box before installation, removal, wiring, or maintenance, otherwise explosion, fire hazard, or electric shock may result.
- Special skills and knowledge of explosion protection, electric system installation, and relevant laws/regulations are required to transport, install, wire, operate, repair, and inspect the EC2B control box. People without such expertise must not use the EC2B control box, otherwise damage or accident may result.
- Do not modify the EC2B, otherwise damage or accident may result.
- Do not use a damaged EC2B control box, otherwise damage or accident may result.
- When connecting external devices, make sure that each cable is connected to the correct terminal, otherwise electric shock, fire hazard, or explosion may result.
- Use wires of a proper size to meet voltage and current requirements. Incorrect wiring may cause abnormal temperature rise and lead to fire hazard and explosion.
- Connect the grounding terminal to a proper ground, otherwise electric shock, fire hazard, or explosion may result.
- Do not sit on or hang from the EC2B control box, otherwise damage, personal injury, or accident may result.
- Do not open the lid of the EC2B control box when it is energized, otherwise electric shock, fire hazard, or explosion may result.
- Operate the EC2B control box at the rated current and voltage specified in this catalog, otherwise short-circuiting, fire hazard, or explosion may result.
- When measuring the insulation resistance of the EC2B control box, make sure that potentially explosive atmosphere of explosive gas or vapor does not exist in the vicinity, otherwise explosion may result. Also, do not touch the terminals without paying attention, otherwise electric shock will result.
- Do not place any obstacles in front of the nameplate.
- Do not remove the nameplate.
- When opening the lid for wiring, maintenance or inspection, make sure that substances such as dust, concrete powder, or metal powder do not enter inside the box, otherwise contact failure or insulation failure may result.
- Do not drop the EC2B control box during transportation.
- Be sure to open the carton the right way up, otherwise damage or personal injury may result.
- Check that the product is what you have ordered. Using an incorrect model might result in malfunction or accident.
- Stop operation immediately if abnormal operation occurs. Otherwise, a secondary accident may occur.
- The surface temperature of the EC2B control box may become extremely hot during operation. Before maintenance or inspection of the EC2B, be sure to wear gloves to prevent burning your hand.

Operating Instructions

- Notes on Use
- Installation Area
- Do not install the EC2B control box in an environment where more than IP65 protection degree (more than Type 4X in North America) is required.
- Use the EC2B control box under ambient temperature of -20 to $+50^{\circ}\text{C}$. If the control box is exposed to direct sunlight and the surface temperature may rise above 50°C , provide a shade (see [page 22](#)) to keep the surface temperature below 50°C .
- Installation
- Wall mount
Use four M6 bolts for 1-column, four M8 bolts for 2- and 3-column, or other methods with equivalent strength to install the control box. Mounting tab thickness is 1.5mm for 1 column and 2mm for 2, 3, and 4 columns. (See dimensions) (See dimensions.)
- Pole mount
Use four M12 bolts or other methods with equivalent strength to install the control box.
Use flat washers to prevent scratches on the pole base coating.
- If bolts become may loose due to vibration, use spring washers.
- If bolt corrosion is anticipated, use anti-corrosion bolts or other countermeasures.
- Notes on Emergency Stop Switches
- When using the emergency stop switches on safety-related parts of the control system, observe safety standards and regulations of the relevant country or region. Also be sure to perform a risk assessment before operation.
- Opening/Closing the Lid
- Use a Philips screwdriver to loosen lid mounting screws. While holding the unhinged side, open the lid slowly without exerting excessive force on the hinge.
- Before closing the lid, make sure of the following:
 - No foreign substances are on the packing or joint surfaces.
 - No displacement of the waterproof packing.
 - Wires are not caught between the joint surfaces.
- Next, close the lid slowly and tighten the screws to a proper torque of 1.6 to 2.4 N·m.

Operating Instructions

Limitation of the Operating Current

- Major heat sources comes from the wiring which is connected to the control box. Therefore, not only the operating current but wiring conditions (size, no. of wires, no. of wire bundles) may cause temperature rise. When wiring, observe the following conditions.
 - Stranded wire: 1.5 to 2.5 mm² (UL-c-UL certified)
1.25 to 2.5 mm² (other)
 - solid wire: ø1.2 to ø1.6 mm (16 to 14 AWG)
 - Maximum no. of wires per bundle: 16
 - Maximum operating current: 10A
- When using the control box under operating environment of 40°C minimum, use a heat resistant cable of 70°C minimum.
- Determine the operating current so that the total heat value of 1 wire bundle is below 300 [A² × wires]. Also, when calculating the heat value, take the current fluctuation (10%) into consideration.

[calculation example: EC2B-41**B (8 circuit)]

ⓐApply 10A to 1 circuit, 1A to the remaining 7 circuits:

$\{(10A \times 1.1)^2 \times 2 \text{ wires}\} + \{(1A \times 1.1)^2 \times 14 \text{ wires}\} \approx 259$
(can be used because < 300)

ⓑApply 10A to 1 circuit, 2A to the remaining 7 circuits:

$\{(10A \times 1.1)^2 \times 2 \text{ wires}\} + \{(2A \times 1.1)^2 \times 14 \text{ wires}\} \approx 310$
(cannot be used because > 300)

2. See the table below for the allowable operating current when applying current evenly to each control box.

Control Box Part No.	Max. No. of Circuits	Max No. of Wires per Bundle (*1) [wires] ([wires]×[bundle])		Allowable Operating Current (reference) (*2)
		Without terminal blocks	With terminal blocks	
EC2B-11 □ B □	3	16 (16×1)	8 (8×1)	7A
EC2B-21 □ B □	6	16 (16×1)	8 (8×1)	5A
EC2B-31 □ B □	9	16 (16×1)	8 (8×1)	4A
EC2B-41 □ B □	12	16 (16×1)	16 (16×1)	3A
EC2B-51 □ B □	15	16 (16×1)	16 (16×1)	3A
EC2B-22 □ B □	12	32 (16×2)	16 (8×2)	5A
EC2B-32 □ B □	18	32 (16×2)	16 (8×2)	4A
EC2B-42 □ B □	24	32 (16×2)	32 (16×2)	3A
EC2B-52 □ B □	30	32 (16×2)	32 (16×2)	3A
EC2B-23 □ B □	18	48 (16×3)	24 (8×3)	5A
EC2B-33 □ B □	27	48 (16×3)	24 (8×3)	4A
EC2B-43 □ B □	36	48 (16×3)	48 (16×3)	3A
EC2B-53 □ B □	45	48 (16×3)	48 (16×3)	3A
EC2B-63 □ B □	54	48 (16×3)	48 (16×3)	3A
EC2B-64 □ B □	72	64 (16×4)	64 (16×4)	3A

*1: Make sure that the number of wires per bundle is a maximum of 16 by reducing the wiring or by jumper wiring. The maximum number of wires per bundle may need to be further reduced depending on the wire size, lead-in fitting, or conduit size.

*2: The allowable current value (reference) when applying current evenly to all circuits of the maximum number of circuits.

Wiring Construction

- Observe the laws and regulations in each country concerning wiring construction.
- Use cable wiring or metal conduit wiring for installation in hazardous locations. If foreign objects or water may enter the box, install a sealing fitting near the cable entry of the box and seal the control box using a compound.
- Standard type control boxes do not contain a terminal block. Wire the control units directly.

Operating Instructions

Wiring

Applicable Wires

Stranded wire: 1.25 to 2.5 mm², solid wire: ϕ 1.2 to ϕ 1.6 mm (AWG16 to 14)

- Do not connect more than 2 wires to the same terminal.

Applicable crimping terminal

- Ring terminals cannot be used for EU2B control units with IP20 finger-safe terminals.
- Ring and spade terminals cannot be used for IP20 clamp type terminal blocks.
- When connecting 2 ferrules to an EU2B control unit, use ferrules without insulating sheath.

For control units EU2B

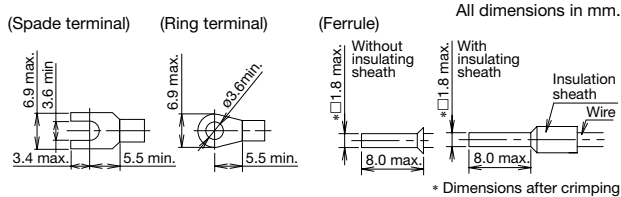

For control units EC9

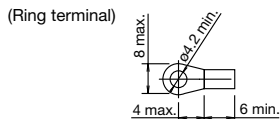

For screw terminal ET2A-8PE

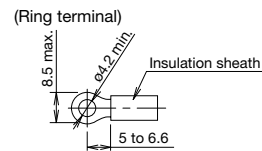

For IP20 clamp terminal (WAGO: 264-238)

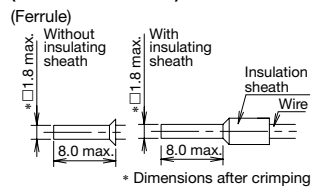

- Recommended crimping terminal (WAGO)
 Ferrule with insulating sheath: 216-204
 Ferrule without insulating sheath: 216-104
 Crimping plier: 206-204

Recommended Tightening Torque

EU2B control units (M3.5) and ET2A-8PE terminal block (M4): 1.0 to 1.3 N·m

Warning

Incorrect wiring may cause fire hazard. Observe the following conditions.

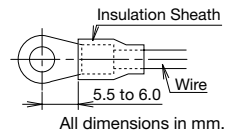

- Be sure to install an insulating sheath on the crimping terminal or the crimping terminal with insulation.
- When connecting solid wires or stranded wires directly, strip the insulation as mentioned below, and insert the wire all the way in.

EU2B Control units: 8.6 mm maximum
 IP20 crimping terminal: 8 to 9 mm

- When using stranded wires, make sure that there are no wire whiskers.
- Make sure that the spade crimping terminals and ferrules are inserted all the way in.
- Use insulated ring terminals for the ET2A-8PE terminal block. Use only applicable crimping terminals and do not directly connect stranded wires or solid wires.

Operating Instructions

Removing and Installing the Contact Unit/Lamp Unit

Removing the Contact Unit/Lamp Unit

To remove the contact unit or the lamp unit from the operator, pull the protruding part of the locking lever outwards as shown in the figure below (using a screwdriver, etc.) and turn it to the left. The contact unit or lamp unit can be pulled out.

Emergency stop switch

Note that when contact unit is detached from the operator part, the NO contact is closed and NC contact is open. Do not move the lock lever when the contact unit is detached (red indicator is protruded), otherwise the switch will be damaged.

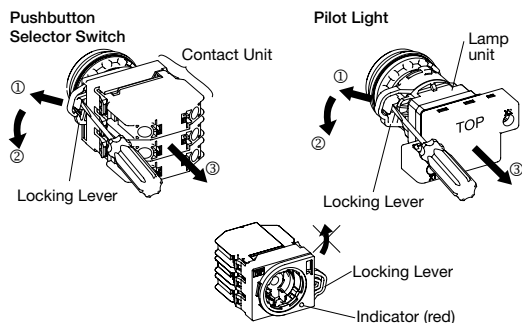

Installing the Contact Unit/Lamp Unit

To install the contact unit, place the TOP marking on the operator and the TOP marking on the contact block adaptor in the same direction, and then attach the contact unit to the operator as shown in the figure below. Then turn the locking lever to the right. Follow the same procedure when installing the lamp unit.

- When installing the lamp unit, check that the inner lens is not loose. Note that the contact units of the emergency stop switch and pushbutton/selector switch are not interchangeable.

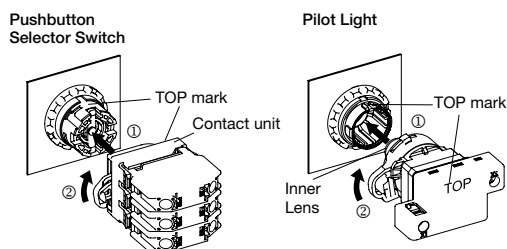

Removing the Contact Block

To remove the contact block, insert a flat screwdriver under the latch of the contact block adaptor and disengage the latch as shown in the figure below.

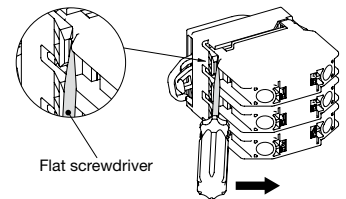

- When installing the contact block after maintenance or wiring, make sure that the contact configuration is correct. Installing the contact block in an incorrect position or incomplete installation may cause malfunction of the switch.
- Make sure to remove the contact block from the operator before installing the contact block to the contact block adaptor. Also make sure that the contact block is correctly installed to the contact block adaptor before attaching the operator. Do not install the contact block adaptor with the operator attached. Otherwise, malfunction may result.

Protective Grounding

Protective grounding must be performed according to the installation environment and rating requirements. Observe laws and regulations set by each country.

- Connect the M4 grounding terminal of the EC2B control box to a proper ground (grounding resistance 10Ω maximum). When operating the EC2B control box by connecting to circuits of 300V or below, the grounding resistance must be 100Ω maximum.
- When using cables, connect one of the cable cores to the grounding terminal in the enclosure.
- If the grounding terminal in the enclosure cannot be used, use the M4 grounding terminal on the outside of the enclosure for wall mount, or the M6 grounding terminal of the pole base for pole mount.

Recommended tightening torque:

M4: 1.0 to 1.3 N·m

M6: 3.9 to 5.4 N·m

For grounding, use appropriate wires (size, material, insulation) that can tolerate the expected maximum grounding current. Be sure to protect the grounding wire with protection, such as metal conduit, from external damage.

Maintenance and Inspection

- Observe laws and regulations set by each country.
- Do not open the lid when inspecting the EC2B while it is energized.
- Never disassemble the control box.
- Do not use tools that cause sparks during maintenance and inspection.
- When using measuring devices, use explosion-protected types.
- When the EC2B needs to be disassembled or assembled for maintenance or repair, contact IDEC.

Disposal

Observe laws and regulations set by each country concerning refuse disposal.



EC2B

1-column Control Box Specification Sheet

TO: IDEC Corporation

Company: _____

TEL: _____

No. of Control Box

Contact Person: _____

FAX: _____

--

Select the required specifications by checking the checkboxes (✓), and specify the details.

1. Certification IECEX/ATEX/Ex-CCC UL/c-UL, IECEX/ATEX

2. Control box size (wall mount only)

EC2B-110

EC2B-210

EC2B-310

EC2B-410

EC2B-510

3. Nameplate (NP) Material: Acrylic (53 mm × 12 mm, plate thickness 2 mm)
 Legend color: black letter, white background
 Maximum no. of letters: 19 letters per line (up to 2 lines)

No nameplate 1 line 2 lines

1st line	
2nd line	

4. Control Units

Position	Control Unit Part No.	Control Unit Nameplate
①		<input type="checkbox"/> ON <input type="checkbox"/> OFF <input type="checkbox"/> START <input type="checkbox"/> STOP <input type="checkbox"/> EMERGENCY STOP <input type="checkbox"/> OFF ON <input type="checkbox"/> HAND AUTO <input type="checkbox"/> HAND OFF AUTO <input type="checkbox"/> Blank <input type="checkbox"/> No nameplate <input type="checkbox"/> Specify letters ()
②		<input type="checkbox"/> ON <input type="checkbox"/> OFF <input type="checkbox"/> START <input type="checkbox"/> STOP <input type="checkbox"/> EMERGENCY STOP <input type="checkbox"/> OFF ON <input type="checkbox"/> HAND AUTO <input type="checkbox"/> HAND OFF AUTO <input type="checkbox"/> Blank <input type="checkbox"/> No nameplate <input type="checkbox"/> Specify letters ()
③		<input type="checkbox"/> ON <input type="checkbox"/> OFF <input type="checkbox"/> START <input type="checkbox"/> STOP <input type="checkbox"/> EMERGENCY STOP <input type="checkbox"/> OFF ON <input type="checkbox"/> HAND AUTO <input type="checkbox"/> HAND OFF AUTO <input type="checkbox"/> Blank <input type="checkbox"/> No nameplate <input type="checkbox"/> Specify letters ()
④		<input type="checkbox"/> ON <input type="checkbox"/> OFF <input type="checkbox"/> START <input type="checkbox"/> STOP <input type="checkbox"/> EMERGENCY STOP <input type="checkbox"/> OFF ON <input type="checkbox"/> HAND AUTO <input type="checkbox"/> HAND OFF AUTO <input type="checkbox"/> Blank <input type="checkbox"/> No nameplate <input type="checkbox"/> Specify letters ()
⑤		<input type="checkbox"/> ON <input type="checkbox"/> OFF <input type="checkbox"/> START <input type="checkbox"/> STOP <input type="checkbox"/> EMERGENCY STOP <input type="checkbox"/> OFF ON <input type="checkbox"/> HAND AUTO <input type="checkbox"/> HAND OFF AUTO <input type="checkbox"/> Blank <input type="checkbox"/> No nameplate <input type="checkbox"/> Specify letters ()

5. Wall Mount Lead-in Fitting (E1/E2)

	EC2B-110, 210, 310	EC2B-410, 510
IECEX/ATEX/Ex-CCC certified	M25	M32
UL/c-UL, IECEX/ATEX certified	NPT 3/4	NPT 1

EC2B-110, 210, 310

Code	Cable lead-in method	Check	Specification
E1	Reducer	<input type="checkbox"/>	M16
		<input type="checkbox"/>	M20
		<input type="checkbox"/>	M25
		<input type="checkbox"/>	M32
		<input type="checkbox"/>	NPT 1/2
		<input type="checkbox"/>	NPT 3/4
		<input type="checkbox"/>	NPT 1
		<input type="checkbox"/>	G1/2 (16)
		<input type="checkbox"/>	G3/4 (22)
		<input type="checkbox"/>	G1 (28)

EC2B-410, 510

Code	Cable lead-in method	Check	Specification
E2	Reducer	<input type="checkbox"/>	M25
		<input type="checkbox"/>	M32
		<input type="checkbox"/>	M40
		<input type="checkbox"/>	NPT 3/4
		<input type="checkbox"/>	NPT 1
		<input type="checkbox"/>	NPT 1 1/4
		<input type="checkbox"/>	G3/4 (22)
		<input type="checkbox"/>	G1 (28)
		<input type="checkbox"/>	G1 1/4 (36)

* G thread is not available on UL/c-UL, IECEX/ATEX certified.

• Specify wiring diagram when wiring is required. • Specify when other accessories are required.



(/)

EC2B TIS Certified Model
1-column Control Box Specification Sheet

TO: IDEC Corporation

Company: _____

TEL: _____

No. of Control Box

Contact Person: _____

FAX: _____

--

Select the required specifications by checking the checkboxes (✓), and specify the details.

1. Mounting method Wall mount Pole mount

2. Control box size

EC2B-110 EC2B-210 EC2B-310 EC2B-410 EC2B-510

3. Nameplate (NP) Material: Acrylic (53 mm × 12 mm, plate thickness 2 mm)
Legend color: black letter, white background
Maximum no. of letters: 19 letters per line (up to 2 lines)

No nameplate 1 line 2 lines

1st line	
2nd line	

4. Control Units

Position	Control Unit Part No.	Control Unit Nameplate
①		<input type="checkbox"/> ON <input type="checkbox"/> OFF <input type="checkbox"/> START <input type="checkbox"/> STOP <input type="checkbox"/> EMERGENCY STOP <input type="checkbox"/> OFF ON <input type="checkbox"/> HAND AUTO <input type="checkbox"/> HAND OFF AUTO <input type="checkbox"/> Blank <input type="checkbox"/> No nameplate <input type="checkbox"/> Specify letters ()
②		<input type="checkbox"/> ON <input type="checkbox"/> OFF <input type="checkbox"/> START <input type="checkbox"/> STOP <input type="checkbox"/> EMERGENCY STOP <input type="checkbox"/> OFF ON <input type="checkbox"/> HAND AUTO <input type="checkbox"/> HAND OFF AUTO <input type="checkbox"/> Blank <input type="checkbox"/> No nameplate <input type="checkbox"/> Specify letters ()
③		<input type="checkbox"/> ON <input type="checkbox"/> OFF <input type="checkbox"/> START <input type="checkbox"/> STOP <input type="checkbox"/> EMERGENCY STOP <input type="checkbox"/> OFF ON <input type="checkbox"/> HAND AUTO <input type="checkbox"/> HAND OFF AUTO <input type="checkbox"/> Blank <input type="checkbox"/> No nameplate <input type="checkbox"/> Specify letters ()
④		<input type="checkbox"/> ON <input type="checkbox"/> OFF <input type="checkbox"/> START <input type="checkbox"/> STOP <input type="checkbox"/> EMERGENCY STOP <input type="checkbox"/> OFF ON <input type="checkbox"/> HAND AUTO <input type="checkbox"/> HAND OFF AUTO <input type="checkbox"/> Blank <input type="checkbox"/> No nameplate <input type="checkbox"/> Specify letters ()
⑤		<input type="checkbox"/> ON <input type="checkbox"/> OFF <input type="checkbox"/> START <input type="checkbox"/> STOP <input type="checkbox"/> EMERGENCY STOP <input type="checkbox"/> OFF ON <input type="checkbox"/> HAND AUTO <input type="checkbox"/> HAND OFF AUTO <input type="checkbox"/> Blank <input type="checkbox"/> No nameplate <input type="checkbox"/> Specify letters ()

5. Wall Mount Lead-in Fitting (E1/E2) • G3/4 screw (22) reducer is used for EC2B-110, 210, 310 types.
(Specification is not necessary for pole mount) • G1 screw (28) reducer is used for EC2B-410, 510 types.
 • Standard reducer is used if unspecified.

EC2B-110, 210, 310

Code	Cable lead-in method	Check	Specification
E1	Reducer (metal conduit)	<input type="checkbox"/>	G1/2 (16)
		<input type="checkbox"/>	G3/4 (22)
		<input type="checkbox"/>	G1 (28)
	Flameproof packing cable lead-in fitting (cable)	<input type="checkbox"/>	ø6 to ø8
		<input type="checkbox"/>	ø8 to ø10
		<input type="checkbox"/>	ø10 to ø12
		<input type="checkbox"/>	ø12 to ø14
		<input type="checkbox"/>	ø14 to ø16
		<input type="checkbox"/>	ø16 to ø18
		<input type="checkbox"/>	ø18 to ø20

EC2B-410, 510

Code	Cable lead-in method	Check	Specification
E2	Reducer (metal conduit)	<input type="checkbox"/>	G3/4 (22)
		<input type="checkbox"/>	G1 (28)
		<input type="checkbox"/>	G1 1/4 (36)
	Flameproof packing cable lead-in fitting (cable)	<input type="checkbox"/>	ø12 to ø14
		<input type="checkbox"/>	ø14 to ø16
		<input type="checkbox"/>	ø16 to ø18
		<input type="checkbox"/>	ø18 to ø20
		<input type="checkbox"/>	ø20 to ø23
		<input type="checkbox"/>	ø23 to ø26

The values in () indicate the nominal sizes.

• Specify wiring diagram when wiring is required. • Specify when other accessories are required.

BGLEN01A EC2B December 2022

IDEC 29

Ordering Terms and Conditions

Thank you for using IDEC Products.

By purchasing products listed in our catalogs, datasheets, and the like (hereinafter referred to as "Catalogs") you agree to be bound by these terms and conditions. Please read and agree to the terms and conditions before placing your order.

1. Notes on contents of Catalogs

- (1) Rated values, performance values, and specification values of IDEC products listed in this Catalog are values acquired under respective conditions in independent testing, and do not guarantee values gained in combined conditions.
Also, durability varies depending on the usage environment and usage conditions.
- (2) Reference data and reference values listed in Catalogs are for reference purposes only, and do not guarantee that the product will always operate appropriately in that range.
- (3) The specifications / appearance and accessories of IDEC products listed in Catalogs are subject to change or termination of sales without notice, for improvement or other reasons.
- (4) The content of Catalogs is subject to change without notice.

2. Note on applications

- (1) If using IDEC products in combination with other products, confirm the applicable laws / regulations and standards.
Also, confirm that IDEC products are compatible with your systems, machines, devices, and the like by using under the actual conditions. IDEC shall bear no liability whatsoever regarding the compatibility with IDEC products.
- (2) The usage examples and application examples listed in Catalogs are for reference purposes only. Therefore, when introducing a product, confirm the performance and safety of the instruments, devices, and the like before use. Furthermore, regarding these examples, IDEC does not grant license to use IDEC products to you, and IDEC offers no warranties regarding the ownership of intellectual property rights or non-infringement upon the intellectual property rights of third parties.
- (3) When using IDEC products, be cautious when implementing the following.
 - i. Use of IDEC products with sufficient allowance for rating and performance
 - ii. Safety design, including redundant design and malfunction prevention design that prevents other danger and damage even in the event that an IDEC product fails
 - iii. Wiring and installation that ensures the IDEC product used in your system, machine, device, or the like can perform and function according to its specifications
- (4) Continuing to use an IDEC product even after the performance has deteriorated can result in abnormal heat, smoke, fires, and the like due to insulation deterioration or the like. Perform periodic maintenance for IDEC products and the systems, machines, devices, and the like in which they are used.
- (5) IDEC products are developed and manufactured as general-purpose products for general industrial products. They are not intended for use in the following applications, and in the event that you use an IDEC product for these applications, unless otherwise agreed upon between you and IDEC, IDEC shall provide no guarantees whatsoever regarding IDEC products.
 - i. Use in applications that require a high degree of safety, including nuclear power control equipment, transportation equipment (railroads / airplanes / ships / vehicles / vehicle instruments, etc.), equipment for use in outer space, elevating equipment, medical instruments, safety devices, or any other equipment, instruments, or the like that could endanger life or human health
 - ii. Use in applications that require a high degree of reliability, such as provision systems for gas / waterworks / electricity, etc., systems that operate continuously for 24 hours, and settlement systems
 - iii. Use in applications where the product may be handled or used deviating from the specifications or conditions / environment listed in the Catalogs, such as equipment used outdoors or applications in environments subject to chemical pollution or electromagnetic interference
If you would like to use IDEC products in the above applications, be sure to consult with an IDEC sales representative.

3. Inspections

We ask that you implement inspections for IDEC products you purchase without delay, as well as thoroughly keep in mind management/maintenance regarding handling of the product before and during the inspection.

4. Warranty

- (1) Warranty period
The warranty period for IDEC products shall be one (1) year after purchase or delivery to the specified location. However, this shall not apply in cases where there is a different specification in the Catalogs or there is another agreement in place between you and IDEC.
- (2) Warranty scope
Should a failure occur in an IDEC product during the above warranty period for reasons attributable to IDEC, then IDEC shall replace or repair that product, free of charge, at the purchase location / delivery location of the product, or an IDEC service base. However, failures caused by the following reasons shall be deemed outside the scope of this warranty.
 - i. The product was handled or used deviating from the conditions / environment listed in the Catalogs
 - ii. The failure was caused by reasons other than an IDEC product
 - iii. Modification or repair was performed by a party other than IDEC
 - iv. The failure was caused by a software program of a party other than IDEC
 - v. The product was used outside of its original purpose
 - vi. Replacement of maintenance parts, installation of accessories, or the like was not performed properly in accordance with the user's manual and Catalogs
 - vii. The failure could not have been predicted with the scientific and technical standards at the time when the product was shipped from IDEC
 - viii. The failure was due to other causes not attributable to IDEC (including cases of force majeure such as natural disasters and other disasters)Furthermore, the warranty described here refers to a warranty on the IDEC product as a unit, and damages induced by the failure of an IDEC product are excluded from this warranty.

5. Limitation of liability

The warranty listed in this Agreement is the full and complete warranty for IDEC products, and IDEC shall bear no liability whatsoever regarding special damages, indirect damages, incidental damages, or passive damages that occurred due to an IDEC product.

6. Service scope

The prices of IDEC products do not include the cost of services, such as dispatching technicians. Therefore, separate fees are required in the following cases.

- (1) Instructions for installation / adjustment and accompaniment at test operation (including creating application software and testing operation, etc.)
- (2) Maintenance inspections, adjustments, and repairs
- (3) Technical instructions and technical training
- (4) Product tests or inspections specified by you

The above content assumes transactions and usage within your region. Please consult with an IDEC sales representative regarding transactions and usage outside of your region. Also, IDEC provides no guarantees whatsoever regarding IDEC products sold outside your region.

IDEC CORPORATION

Head Office 6-64, Nishi-Miyahara-2-Chome, Yodogawa-ku, Osaka 532-0004, Japan

USA IDEC Corporation
EMEA APEM SAS

Singapore IDEC Izumi Asia Pte. Ltd.
Thailand IDEC Asia (Thailand) Co., Ltd.
India IDEC Controls India Private Ltd.

China IDEC (Shanghai) Corporation
IDEC Izumi (H.K.) Co., Ltd.
Taiwan IDEC Taiwan Corporation

 www.idec.com

Japan IDEC Corporation

Specifications and other descriptions in this brochure are subject to change without notice.

2022 IDEC Corporation, All Rights Reserved.

